



This is a digital copy of a book that was preserved for generations on library shelves before it was carefully scanned by Google as part of a project to make the world's books discoverable online.

It has survived long enough for the copyright to expire and the book to enter the public domain. A public domain book is one that was never subject to copyright or whose legal copyright term has expired. Whether a book is in the public domain may vary country to country. Public domain books are our gateways to the past, representing a wealth of history, culture and knowledge that's often difficult to discover.

Marks, notations and other marginalia present in the original volume will appear in this file - a reminder of this book's long journey from the publisher to a library and finally to you.

Usage guidelines

Google is proud to partner with libraries to digitize public domain materials and make them widely accessible. Public domain books belong to the public and we are merely their custodians. Nevertheless, this work is expensive, so in order to keep providing this resource, we have taken steps to prevent abuse by commercial parties, including placing technical restrictions on automated querying.

We also ask that you:

- + *Make non-commercial use of the files* We designed Google Book Search for use by individuals, and we request that you use these files for personal, non-commercial purposes.
- + *Refrain from automated querying* Do not send automated queries of any sort to Google's system: If you are conducting research on machine translation, optical character recognition or other areas where access to a large amount of text is helpful, please contact us. We encourage the use of public domain materials for these purposes and may be able to help.
- + *Maintain attribution* The Google "watermark" you see on each file is essential for informing people about this project and helping them find additional materials through Google Book Search. Please do not remove it.
- + *Keep it legal* Whatever your use, remember that you are responsible for ensuring that what you are doing is legal. Do not assume that just because we believe a book is in the public domain for users in the United States, that the work is also in the public domain for users in other countries. Whether a book is still in copyright varies from country to country, and we can't offer guidance on whether any specific use of any specific book is allowed. Please do not assume that a book's appearance in Google Book Search means it can be used in any manner anywhere in the world. Copyright infringement liability can be quite severe.

About Google Book Search

Google's mission is to organize the world's information and to make it universally accessible and useful. Google Book Search helps readers discover the world's books while helping authors and publishers reach new audiences. You can search through the full text of this book on the web at <http://books.google.com/>

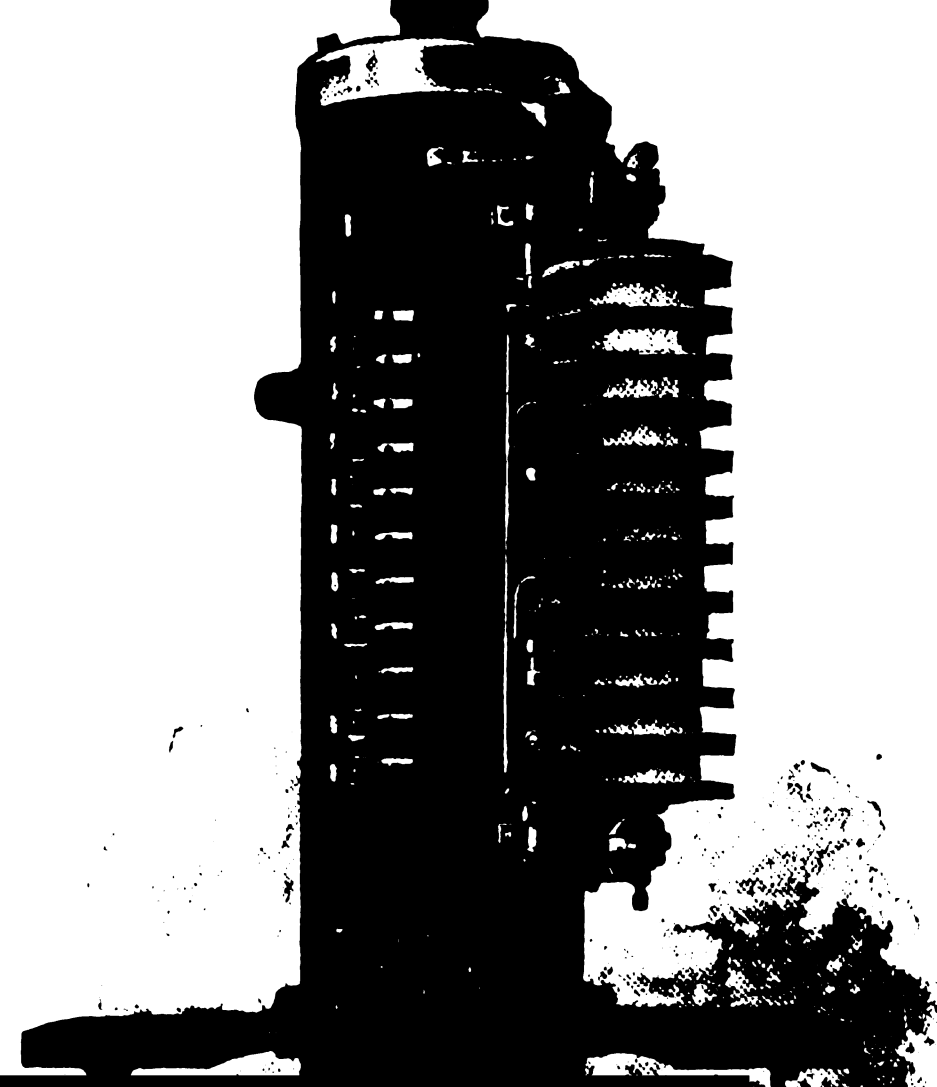

*Westinghouse electric street
car equipments*

Frederick L. Hutchinson, Leo A. Phillips

REESE LIBRARY

OF THE

UNIVERSITY OF CALIFORNIA.

Received *Mar.*, 189*7*.

Copies No. *65035*. Class No.

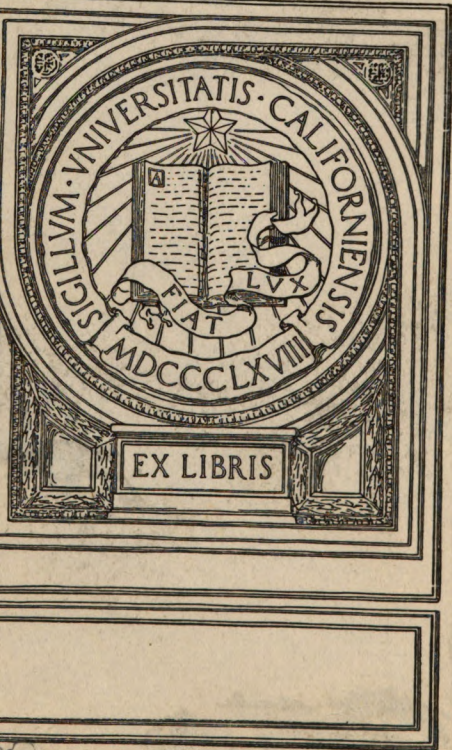



WESTINGHOUSE
ELECTRIC STREET CAR
EQUIPMENTS.

CONTAINING A DESCRIPTION OF THE VARIOUS MOTORS,
CONTROLLERS AND OTHER ELECTRIC STREET CAR
APPARATUS MANUFACTURED BY THE WESTING-
HOUSE ELECTRIC AND MANUFACTURING COM-
PANY; WITH DETAILED INSTRUCTIONS FOR
THE OPERATION, INSPECTION AND RE-
PAIR OF SAME; ALSO, FULL DIREC-
TIONS FOR LOCATING AND
REMEDYING FAULTS.

BY
FREDERICK L. HUTCHINSON
AND
LEO A. PHILLIPS,

ASSOCIATE MEMBERS OF THE AMERICAN INSTITUTE OF
ELECTRICAL ENGINEERS.

ROSE BROS
OF THE
AMERICAN
INSTITUTE OF
ELECTRICAL ENGINEERS

EAST PITTSBURG, PA.
1896.

TF920
H9

65035

COPYRIGHT, 1896,

BY

F. L. HUTCHINSON

AND

L. A. PHILLIPS.

CONTENTS.

	Page
PREFACE	5
CHAPTER I.	
ELECTRICAL UNITS AND TERMS	7
CHAPTER II.	
DESCRIPTION OF WESTINGHOUSE STREET CAR MOTORS . .	13
CHAPTER III.	
DESCRIPTION OF CONTROLLERS AND OTHER CAR AP- PARATUS	27
CHAPTER IV.	
OPERATION OF THE CAR EQUIPMENT	47
CHAPTER V.	
INSPECTION	57
CHAPTER VI.	
HOW TO LOCATE AND REMEDY FAULTS	62
CHAPTER VII.	
REPAIRS, RE-WINDING ARMATURES, ETC.	68

ERRATA.

The reader is requested to note the following corrections:

On page 53, line 7, *instead of* "with diverter resistance,"
read "with no diverter resistance."

On page 66, line 13, *instead of* "if not the motor is
grounded" *read* "if so the motor is grounded."

On pages 42, 43 and and 61, the word "non-arching"
should read "non-arcng."

PREFACE.

Electric traction, although a comparatively new branch of applied science, has, owing to its rapid development, become one of the most important applications of electric energy. The advantages of the electric system of street car propulsion have been clearly demonstrated. It is unfortunate, however, that the profits of many roads are largely decreased, owing to the employment of inexperienced men. The fact that the manner in which each motorman, conductor, car inspector, repair hand and station man performs his work, has a certain influence upon the dividends of the company, seems to be lost sight of by many railway officials.

All electric railway employees should be thoroughly familiar with the apparatus they are handling; and in most cases employees are willing and anxious to learn about the operation of the various electrical devices whenever they have the opportunity.

The object of this little book is to give a complete description of the various street car motors and car equipment apparatus manufactured by the Westinghouse Electric and Manufacturing Company; to give complete directions for the proper inspection and repair of the same; to explain in detail the operations of the various devices, and also to give explicit instructions for locating and remedying any electrical trouble that may be encountered. The writers have endeavored to put all directions, diagrams and illustrations into such form as to be readily understood by any ordinary man, without previous electrical training, and have aimed to give practical rather than theoretical information.

As it is obviously impossible to properly cover more than a small portion of the broad subject of electric railways in a book of this size, the writers concluded to confine themselves to the electrical equipment of the cars, leaving questions of theory to the many excellent books which have been published upon that branch of the subject. It has been considered advisable, however, to insert at the beginning of the book a short chapter containing definitions and brief explanations of many of the units and terms commonly used in electric railway work.

The principal point for all employes to remember is that the ability to keep everything clean and in good order is much more important than the ability to correct faults after they are allowed to appear. The liability to accidents may be reduced and the profits of the road correspondingly increased, by careful inspection at regular intervals, and this should be insisted upon. The saving in repairs will more than balance the cost.

The writers desire to express their obligations to the Westinghouse Electric and Manufacturing Company for many of the cuts contained herein.

EAST PITTSBURG, PA.,

MARCH, 1896.

CHAPTER I.

ELECTRICAL UNITS AND TERMS.

Resistance.—All substances offer more or less resistance to the passage of an electric current. Any substance having small resistance is said to possess high conductivity; in other words, it is a good conductor. Metals offer less resistance than other substances; silver being the best electrical conductor known, while copper is almost as good. On account of the great difference in the commercial value of these two metals however, copper is used almost exclusively as a conductor in ordinary electrical work.

Insulators.—Substances having very high resistance and consequently small conductivity, are called insulators; examples are: glass, dry wood, porcelain and rubber.

Electromotive Force is that force "which moves or tends to move electricity from one point to another"; it is often called electrical pressure. The letters E. M. F. are usually employed to represent electromotive force.

Difference of Potential is really another name for E. M. F. In a water pipe a difference of level produces a pressure which causes the water to flow as soon as a faucet is turned on. Similarly an electrical difference of potential between two points produces an electrical pressure or E. M. F. and this causes the current to flow whenever the circuit is closed.

Current is the electrical movement produced in a conductor by an E. M. F. in opposition to resistance.

The Ohm is the unit of resistance, the letter R being used as an abbreviation; thus, if we have a conductor of ten ohms resistance we may write: $R=10$. Some idea of the resistance of

different sizes of copper wire may be formed from the following table. It must be remembered however, that the figures given are only rough approximations.

Length in Feet.	Size of Wire (American Gauge.)	Resistance.
1000	Number 20	About 10 Ohms.
1000	" 16	" 4 "
1000	" 13	" 2 "
1000	" 10	" 1 "
2000	" 7	" 1 "
4000	" 4	" 1 "
10000	" 0	" 1 "
20000	" 0000	" 1 "

The Volt is the unit of E. M. F. and is usually represented by the letter E.

The Ampere is the unit of current; one ampere being the amount of current produced by one volt E. M. F. acting upon a circuit having one ohm resistance.

Ohm's Law.—In dealing with direct currents, such as used in electric railway work, the three units mentioned above are related in the following simple manner: The current is equal to the E. M. F. divided by the resistance; or, $C = \frac{E}{R}$. That is, the number of amperes flowing in a circuit can always be found by dividing the number of volts, by the number of ohms resistance in the circuit. This relation is known as Ohm's law. So also we can find the resistance by dividing the E. M. F. by the current, or $R = \frac{E}{C}$. If we know the current and resistance we have, $E = C \times R$.

The Watt is the unit of electric power. The number of watts being expended in a circuit at any time is found by multiplying the volts by the amperes; or watts = $E \times C$.

An Electrical Horse Power is equal to 746 watts; so, if we desire to know the amount of work being done at any time in a railway circuit, we multiply the volts by the amperes and divide by 746; or $H. P. = \frac{E \times C}{746}$.

A Kilowatt is 1000 watts, and is therefore equivalent to about one and one-third H. P.

Series and Parallel Arrangement.—If we have two or more conductors connected together so that the current passes successively through each of them, as shown in Fig. 1, they are

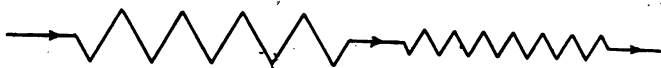

FIG. 1.

said to be in series. If we have a number of conductors connected so that the current, flowing between two points, is di-



FIG. 2.

vided among them, as in Fig. 2, the conductors are said to be in parallel or multiple, or are in shunt with one another.

A Dynamo or Generator is a machine used to generate electrical energy when supplied with mechanical power. All generators depend for their action upon the principle discovered by Michael Faraday in 1831: that if a closed electrical conductor be moved in a magnetic field, in such a way as to cut the magnetic lines of force, an electric current will be produced in that

conductor. The two essential parts of a dynamo are the field magnets and the armature.

The Field Magnet is an iron yoke or frame with pole pieces. Coils of wire called field coils are placed on the field magnet. Current flowing through these coils produces a strong magnetic field at the ends of the pole pieces.

The Armature is usually an iron core, having the form of a drum or ring, mounted upon a shaft, with copper conductors wound, or imbedded in slots, upon its surface. When the armature revolves the copper conductors cut across the magnetic field referred to above and this generates an E. M. F.

Railway Generators are usually designed to generate from 500 to 600 volts; as this is the pressure at which nearly all electric railways are operated.

The Commutator is a structure composed of insulated copper bars, to which the armature conductors are connected. It is keyed to the armature shaft and consequently rotates with it.

The Brushes are conductors which rub against the revolving commutator and collect the current. On a generator the brush or brushes by which the current leaves the commutator are called positive or +; and the brush or brushes by which the current returns to the commutator are called negative or —.

Brush Holders are devices for holding the brushes in place.

Motors are really dynamos, only they perform the reverse operation; that is, they are supplied with electrical energy and give out mechanical power. Motors are wound differently for different purposes. In street railway work the speed and load change continually and frequent stops are necessary. Everyone is familiar with the fact that much more power is required to start a car than to keep it in motion after it is started. Therefore for street railway work a motor is required that will develop great power at starting and is capable of running at various speeds.

Only a series wound motor answers these requirements; and consequently this type exclusively is used for this purpose.

A Series Wound Motor is one in which the entire current passes through the field coils and the armature conductors in series.

A Fuse is a strip of metal, placed in the circuit, of such a size that it will melt if the current increases beyond a safe limit; thus opening the circuit and preventing the apparatus from being damaged.

A Short Circuit means that the wires have become crossed or connected so as to form a shunt or by path of comparatively small resistance, through which so much of the current passes as to practically cut out a part of the original circuit. In cases where the part so cut out possesses considerable resistance, the generator will be called upon to give a very heavy current and the armature might be burned out if there were no safety devices in the circuit.

A Ground on a dynamo or motor means that some portion of the winding on the armature or field coils has come in electrical contact with the iron core or frame.

A Ground on the Line.—In all single trolley railway work the usual practice is to use the rail and ground as the negative side of the circuit, consequently if any part of the trolley line becomes grounded it is equivalent to a short circuit.

A Street Car Controller is a combination of switches by means of which the motors are started, stopped, reversed, and their speed regulated. It is usually mounted with a suitable covering upon the car platform.

A Street Car Diverter is a resistance box or rheostat, used for reducing the current when starting the car; thus preventing sudden jerking of the car and unnecessary strain on the motors.

A Magneto Bell is an instrument which is really a small

electric generator, operated by hand, with a signal bell in series with it. When the circuit is closed and the handle turned, the bell rings. It is used for testing circuits to see if connections are correct, &c., and is very useful, especially when cars are being wired.

An Ammeter is an instrument which indicates the number of amperes flowing through the circuit in which it is connected.

A Voltmeter indicates the voltage or E. M. F. between the two points to which its terminals are connected.

An Automatic Circuit Breaker is an instrument which takes the place of a fuse. This instrument automatically opens the circuit when the current exceeds a certain set limit. The advantages of this device over a fuse are that it is much more accurate and when the circuit has been opened it may be closed again very quickly by simply throwing the handle.

The Path of the Current in a railway circuit is as follows: Starting from the positive terminal of the generator it passes through wires or cables to the switchboard on which are mounted the measuring instruments, switches, and automatic circuit breakers. From the switchboard it is conducted to the trolley line, from which it passes through the motors to the rails and then back to the power house and negative terminal of the generator. This makes a complete closed circuit. If the circuit is opened from any cause, as, for instance, by the automatic circuit breaker, the current will instantly cease flowing until the circuit is again closed.

CHAPTER II.

DESCRIPTION OF WESTINGHOUSE STREET CAR MOTORS.

In designing and constructing a street railway motor there are several important points that must receive due consideration in order to produce an efficient, reliable, and economical machine.

First.—Each individual part must be sufficiently strong, not only to withstand the most severe strains that it will meet with in practice, but an extra margin of strength must be provided for safety.

Second.—It must be designed with due regard to accessibility of the various parts for inspection and repair. This is important on account of the naturally inconvenient position of the motor.

Third.—All the interior parts must be well protected from moisture and dirt.

Fourth.—The perfect insulation of the field and armature windings is absolutely essential.

In the design and construction of the Westinghouse motors the above points as well as all the electrical and mechanical details have evidently received much thought and attention. To his fact is due the present popularity and excellent reputation of these motors.

A Westinghouse Street Car Equipment consists of the following apparatus: 2 motors, 2 gears, 2 pinions, 2 controllers, 1 diverter (for convenience in handling, the diverter is in two or more parts in the later types), 1 lightning arrester, 1 choke coil, 2 canopy switches, 1 fuse box, 1 trolley, wire cables, and lighting circuit details.

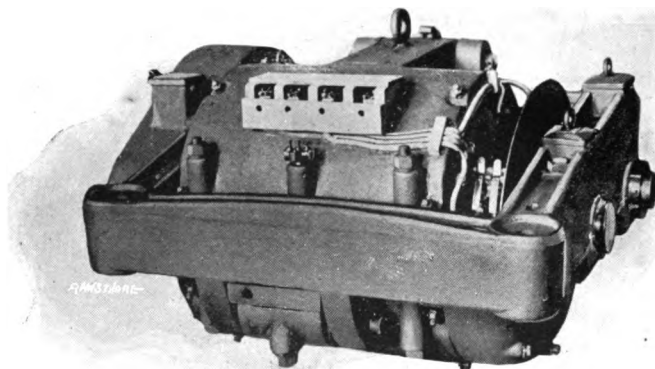

FIG. 3.—NO. 3 SINGLE REDUCTION RAILWAY MOTOR CLOSED.

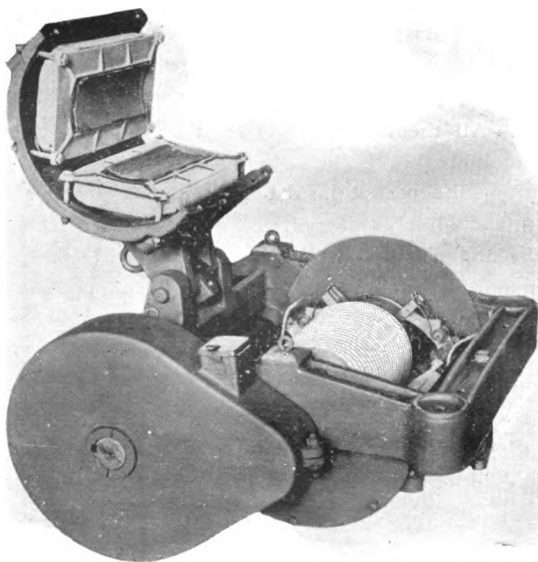

FIG. 4.—NO. 3 SINGLE REDUCTION RAILWAY MOTOR OPEN.

Several different styles of motors and car apparatus are manufactured by the Westinghouse Co. These will be described in the order in which they were placed upon the market.

The No. 3 Motor.—After experimenting with double reduction, gearless, and single reduction motors, the use of a four pole single reduction motor was finally decided upon as best suited to the varying conditions of electric traction and consequently the well known No. 3 motor was designed and placed

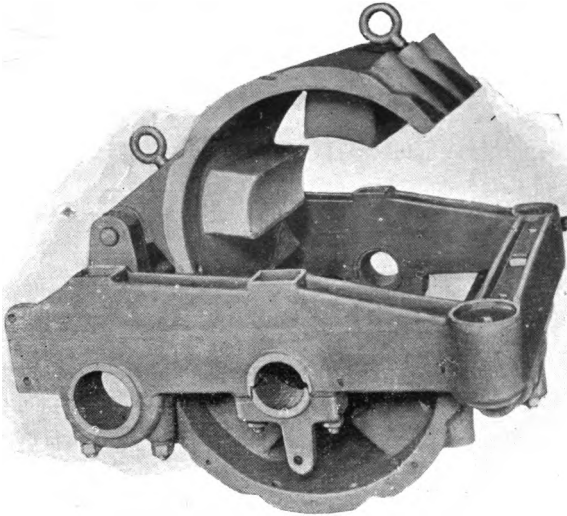

FIG. 5.—NO. 3 MOTOR CASTINGS.

upon the market. This motor is clearly shown (closed) in the illustration, Fig. 3. Another view is presented in Fig. 4 showing the motor open. The lower part of the motor is seen to be entirely shut in, thus affording complete protection to the armature and field coils from moisture and dust. Fig. 5 shows the castings which form the field magnets and frame. There are three stand-

ard sizes of the No. 3 single reduction motor: 20, 25, and 30 horse power. The general form and construction of these three sizes are similar and this description will apply to all.

The field consists of four poles projecting radially inward from a circular yoke divided in a plane through the armature shaft. The principle advantages of the four pole type over the two pole are:

First.—Slower speed of the armature, rendering the use of double reduction gears unnecessary.

Second.—A circular field casting may be used, affording a stronger and more compact structure and possessing a shorter magnetic circuit.

The frame on which the motor is mounted is a distinguishing feature of the No. 3 motor. This frame is made of cast iron, rectangular in shape and sufficiently strong to withstand the greatest strains. The two castings forming the field yoke are hinged to this frame. The field coils are carefully wound on moulds in a winding lathe, then insulated with fullerboard and mica. When completed, one is slipped on each pole piece and held in place by cast brass plates bolted to the yoke.

The armature of the No. 3 motor is of the drum type. The core is composed of thin sheet iron discs between $\frac{3}{4}$ inch end plates, and is keyed directly to the shaft. The armature is of the slotted type; that is, there are slots on the surface of the core to receive the coils, as shown in Fig. 6.

The armature coils are wound on a mould with No. 11 wire then inclosed in an insulating cell composed of fullerboard and mica and finally completed by being covered with heavy insulating tape. The next step is placing the coils on the core or winding the armature. There are 95 slots in the armature, the coils are placed on in two layers. A complete description of the method of winding and connecting to the commutator will be found in the chapter on Repairs. After the armature is wound and con-

nected, outside insulation is put on as an additional protection and held in place by band wires, which are put on with considerable tension. Another purpose of the band wires is to prevent the coils from being thrown out of the slots by centrifugal force.

The method of connecting the coils to the commutator is such as to produce what is known as a two circuit winding; that is, there are two, and only two, circuits in which the current flows through the armature. This style of connection prevents the armature circuits from becoming unbalanced electrically; that is, one part of the winding cannot carry more current than another.

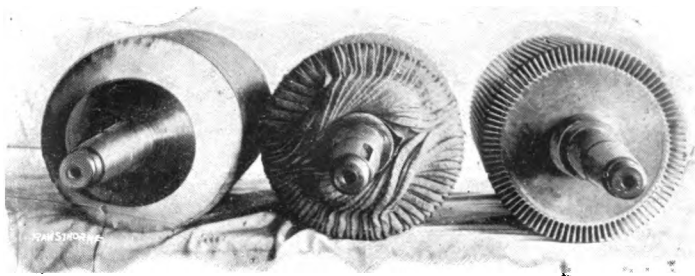

FIG. 6.—No. 3 MOTOR ARMATURES IN CONSTRUCTION.

When the wear of the bearings allows the armature to approach slightly nearer the lower pole pieces the effect of these poles becomes relatively greater than that of the upper ones. If more than a two circuit winding were used a part of the winding would do more than its share of the work owing to the unequal action of the different poles. This would cause excessive heat, waste of energy, and injury to the insulation.

With a two circuit winding however, each winding is affected to the same extent and no unbalancing is possible. We could remove two poles entirely and the armature would still re-

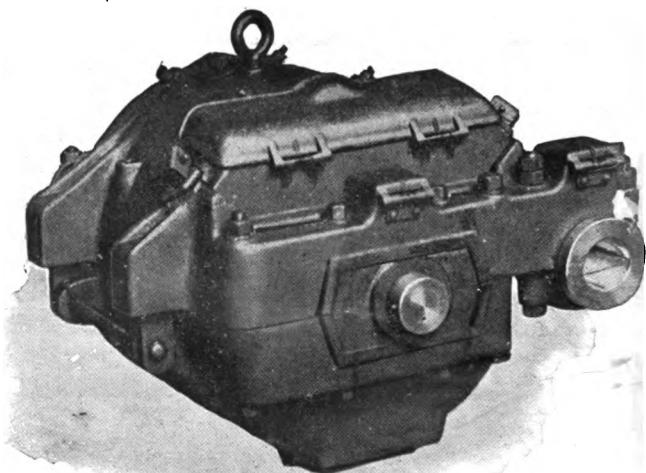

FIG. 7.—No. 12 MOTOR CLOSED.

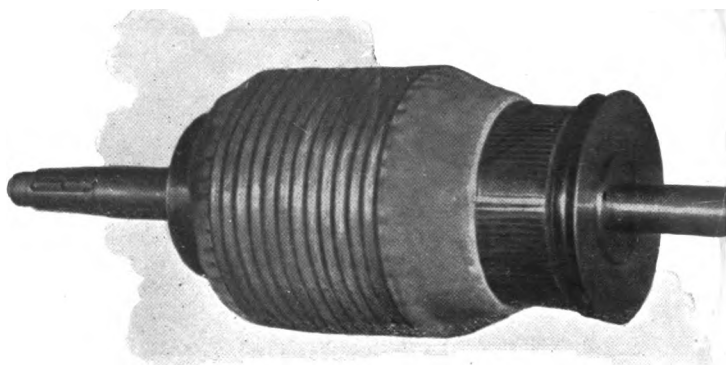

FIG. 8.—No. 12 MOTOR, ARMATURE COMPLETE.

volve from the action of the remaining two. This may be done without shifting the brushes and without causing sparking, since the position of the neutral point is not changed.

The brushes are placed 90 degrees apart on the upper side of commutator, the brush holder being held in place by wooden blocks securely fastened to the frame.

Mounted on top of the No. 3 motor is a wooden terminal box containing four brass terminals, from each of which wires lead into the motor, two to the fields and two to the armature. The current is brought to the motor by means of wires which are also attached to these terminals.

The No. 3 motor is suspended at one end by two springs mounted upon the truck, the other end of motor being carried upon the axle. The armature shaft and car axle are rigidly held in the rectangular frame of motor and consequently are maintained in a perfectly parallel position and perfect meshing of the gears is assured.

Although the No. 3 motor was one of the earliest types manufactured by the Westinghouse Co., it has proved itself so excellently adapted to its purpose that it is still a strong favorite with many roads, and there are probably more No. 3 motors in use than any other single type in the world.

The No. 12 Motor.—This motor was brought out later than the No. 3. It was wound for 20, 25 or 30 horse power, and resembles the No. 3 with the exception that the iron frame which serves as a support for the No. 3 is absent; thus reducing the weight, which is an important point. Another improvement is in the method of suspension, which will be described later.

The armature is of the drum type like that of the No. 3, but shorter. There are 47 slots in this armature and the commutator has 93 bars. The coils are machine wound and enclosed in fuller-board and mica cells. This armature is also connected so as to give a two circuit winding, requiring two brushes.

Thus it is seen that the construction of the armature is very similar to that of the No. 3 motor—see Fig. 8.

The castings of the No. 12 motor, as before stated, are considerably lighter than those of the No. 3. Half of the circular yoke, the two lower pole pieces, and the end plates are made in one casting, thus giving strength and at the same time protecting the lower half of the motor. The rectangular frame, which was a separate casting in the No. 3, has been combined with the upper field casting, as shown in Fig. 9. The two halves of the yoke are hinged together on the side opposite to the axle, thus rendering the interior parts of the motor easily accessible. There are two openings in the lower field castings one; below the commutator and one at the other end of the casting. These are closed by water tight covers. The upper casting has a large opening just above the commutator which is provided with a hinged cover, thus enclosing and protecting the commutator.

The No. 12 motor possesses great practical advantages in regard to the means provided for quick inspection of armature, commutator, brushes, field coils, &c. The hinged cover referred to above provides means of readily inspecting and handling commutator and brushes. If it becomes necessary to remove armature or field coils for repair the car can be run over a pit and the bottom field casting lowered, either with or without the armature. The armature bearings are enclosed in a pillow block, which, when motor is closed, is bolted to both upper and lower field castings. If it is desired to remove the armature, the bolts holding the pillow block to upper field are removed and the lower casting then dropped with armature, which can then be rolled out. Or the armature can be left in the upper field and the field coils in lower half can be removed.

By the above arrangement of the motor, repair work can be accomplished entirely from the pit, without the inconvenience of introducing grease and dirt into the car.

The field coils are wound and insulated practically in the same manner as the No. 3 coils. The brushes and brush holders are placed 90 degrees apart on the upper side of commutator and the holders are held in position by wooden blocks mounted upon

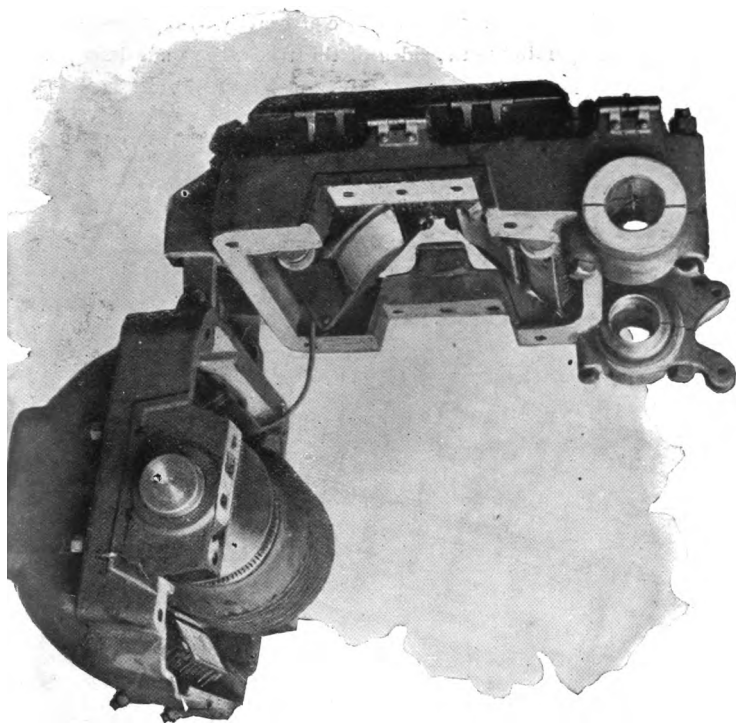

FIG. 9.—NO. 12 MOTOR OPEN, WITH ARMATURE IN LOWER FIELD.

an iron frame designed to form part of the upper field casting.

No contact box is used on the No. 12 motor, the leads from the field and armature being brought out through insulated bush-

ings in the upper yoke; those from the brushes, at the commutator end and the two from the field coils at the other end.

Suspension.—The method of suspension of the No. 12 motors is a great improvement on that of the No. 3 and relieves the axle of practically all the weight of the motor, which is suspended directly in line of its centre of gravity by suspension bars which run parallel to the sides of the truck, the ends being sup-

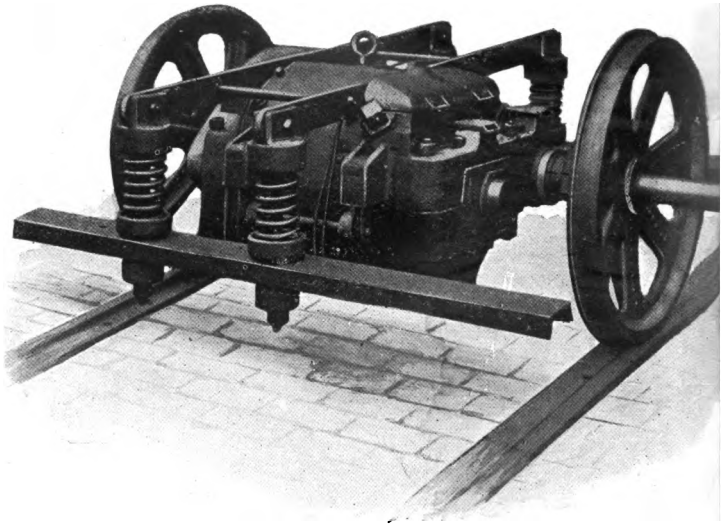

FIG. 10.—NO. 12 RAILWAY MOTOR, SHOWING SUSPENSION.

ported on spiral springs. This is called the parallel bar suspension, and is clearly shown in Fig. 10. By this suspension the jarring of the motor is avoided and the meshing of the gears accurately maintained; it prevents hammering of the rails, increases the comfort of the passengers and reduces the wear of the motors and trucks to a minimum.

The No. 10 Motor.—This motor was built on the same general plan as the No. 12, but was designed for 40 and 50 horse power.

The No. 12A Motor is a development of the No. 12, and is very similar to it in many respects. The description that has been given of the No. 12 will apply to the 12A, with the following exceptions: The armature is wound with what is known as a ventilated winding, which will be described in the last paragraph of this chapter. The armature and commutator are completely enclosed in the 12A, thus affording perfect protection. The pillow block which supported the armature bearings in the No. 12 has been dispensed with, and the bearings are fitted directly in a recess between the upper and lower field castings.

The No 36, 40 Horse Power Motor is very similar in appearance to the 12A. In fact, it is practically the same, except it was designed for 40 horse power, while the 12A is built for 25 and 30 horse power. The armature coils are of the ventilated type.

The No. 38, 50 Horse Power Motor has been but recently placed upon the market. In general form it is quite similar to the 12A, but larger and stronger. The designers have retained all the advantages of the other types and have added important improvements; the result is a strong and highly efficient motor, which is excellently adapted to its purpose.

The yoke is made of cast steel, with pole pieces of laminated iron. The armature is of the ventilated type. The castings entirely enclose the interior parts, which are thus well protected from moisture and dust.

Ventilated Armatures.—In the No. 3 and No. 12 armatures the coils overlap at the ends, as shown in Fig. 6, and, in winding, are hammered tightly against each other. This, and the fact that the coils are covered at the ends by a canvas jacket,

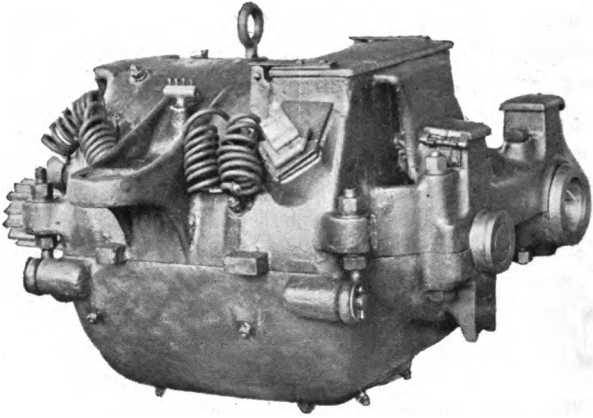

FIG. 11.—NO. 12A RAILWAY MOTOR CLOSED.

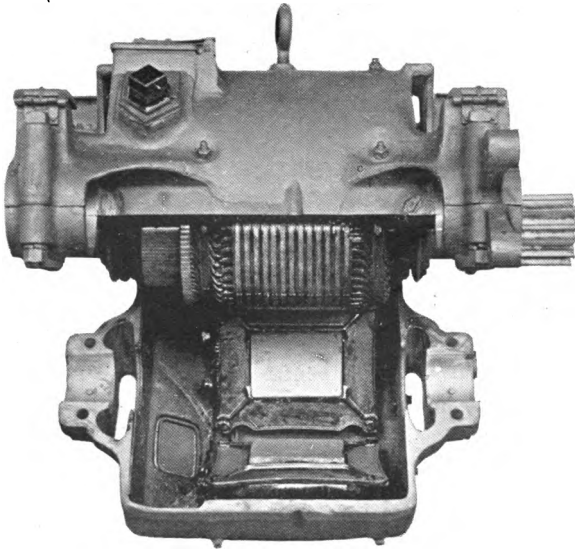

FIG. 12.—NO. 12A RAILWAY MOTOR OPEN.

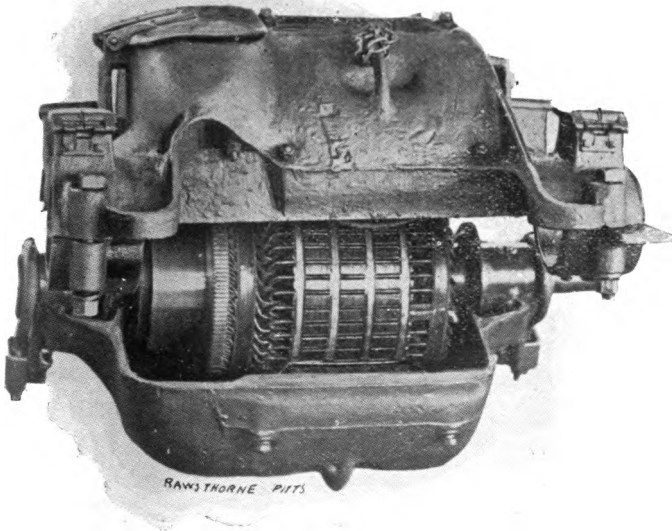

FIG. 13.—NO. 38 RAILWAY MOTOR.

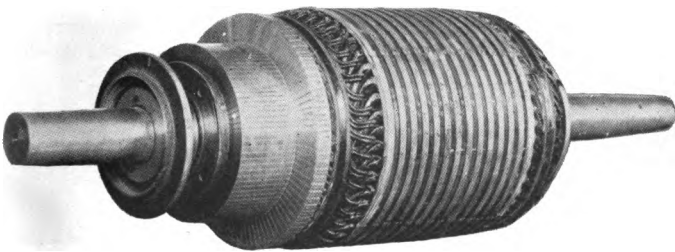

FIG. 14.—VENTILATED ARMATURE FOR NO. 12A RAILWAY MOTOR.

impedes the radiation of heat, especially from the coils near the bottom.

These facts have led to the design of a ventilated form of armature—see Fig. 14. In this the armature core is provided with air passages parallel to the shaft, which permit of rapid radiation of any heat generated in the armature. The armature coils are wound on moulds in such shape that they need only be slipped into the slots. They are not hammered at the ends, but retain their original shape, the insulated coils being separated from each other at the ends by air spaces, thus providing excellent means of ventilation. This is a great improvement over the former types. The No. 12A, 36 and 38 motors, are all provided with armatures of the ventilated type.

CHAPTER III.

DESCRIPTION OF CONTROLLERS AND OTHER CAR APPARATUS.

The controlling apparatus for regulating the speed of electric cars is second only, in importance, to the motors. The design of the controller depends primarily upon whether one or more motors are to be controlled. With single motor equipments it is only necessary to provide means for reversing, and inserting or withdrawing resistance in series with, the motor. When more than one motor is mounted on a car, however, they may be connected in series or parallel; therefore, the classification of controllers naturally falls under two heads:

First.—The multiple or parallel controller, by which variation in speed is obtained by changing the amount of resistance in the motor circuit, the motors being always connected in parallel.

Second.—The series-parallel controller, which enables the motors to be started in series and afterwards thrown in parallel.

Single motor equipments are usually provided with a parallel controller or a modification of the series parallel type.

Several different types of street railway controllers and the corresponding diverters have been manufactured by the Westinghouse Co., and they are known as follows:

Controllers	Type	Diverters
D	Parallel	D
G	Series-Parallel	E
No. 14	“ “	No. 7
No. 28	“ “	No. 46
No. 29	“ “	No. 47
No. 28A	“ “	No. 46 or 47
No. 38	“ “	No. 38

Generally speaking, any of the motors described in the previous chapter can be operated by any one of the controllers mentioned above, with the exception of the No. 38, 50 horse power motor, which should be operated by either a No. 29 or No. 38 controller. The usual practice, until very recently, has been to provide "D" or "G" controllers with No. 3 motors, No. 14 Controllers with No. 12 motors, and No. 28 controllers with "12A" or "36" motors.

The No. 28A and No. 38, however, are the latest designs, and are now the standard Westinghouse controllers. All controllers are stamped on the front side of top plate with the type letter or number, and the serial number; for instance, ^G15168 or 28A 17364.

The D Controller consists of a cylindrical drum, mounted upon a square steel shaft, composed of insulated contact rings moulded upon the shaft with an insulating material. The inner sides of the contact rings are covered with amyloidon, an insulating and fire proof covering. The drum is then mounted upon suitable bearings, the upper end of the shaft, projecting through the top plate, is provided with a handle for operating. Contact arms are mounted upon the controller back and connected to the terminals alongside of drum. As the drum is rotated the contact rings make successive connections with the arms. By means of these connections the various combinations which produce the different speeds are obtained. A ratchet wheel at the top of cylinder distinguishes the various positions of the handle, thus enabling the motorman to tell by a sense of feeling what position he is running on and rendering it unnecessary for him to keep his eyes on the handle. The controlling stand is completely enclosed by a water-tight and fire-proof covering. A detailed description of the method of operating the controller will be given in another chapter.

The D Diverter consists of a cast iron frame, containing coils of flat iron wound compactly between sheets of mica. The

function of the diverter is primarily to reduce the current when starting, so that the car may be easily and gradually gotten up to

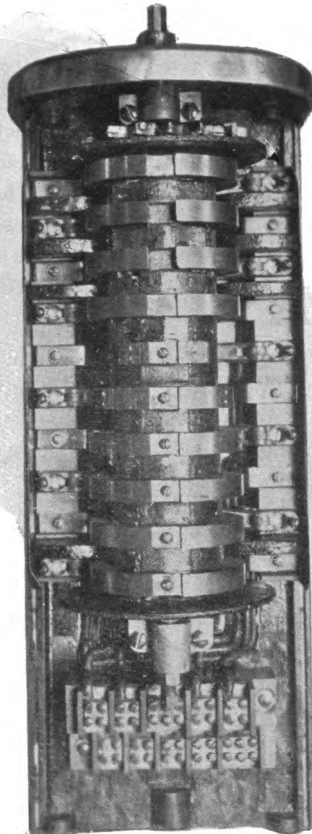

FIG. 15.—TYPE "D" PARALLEL CONTROLLER.

speed and the motors saved from sudden and injurious jerks; the diverter also allows variation in speed and permits slow running through crowded streets. The frame containing the coils is secured

under the car body, and, being strong, simple and fire-proof, requires no attention other than an occasional inspection of the connections.

Series-Parallel Controllers.—The necessity for an economical method of starting and handling electric street cars under the widely varied requirements met with in city and suburban traffic has led to the design of the Series-Parallel system of regulation. When two motors are in series with each other, the total current flows successively through each, with half the applied E. M. F. on each. When two motors are in parallel with each other, approximately half the total current flows through each, but with the total applied E. M. F. on each one; for example, take a car equipped with two motors and parallel controllers, running on the first notch. Assume each motor is taking approximately 25 amperes at 162.5 volts. About 100 volts are used in overcoming the counter E. M. F., leaving 62.5 volts for forcing the 25 amperes through the motor against the resistance of field coils and armature. Now, if the trolley pressure is 500 volts, we have: Total current used for the two motors is $25 \times 2 = 50$ amperes.

Volts.		Amperes	=	Watts.	
500	x	50	=	25,000	consumed from power house.
162.5	x	50	=	8125	consumed by the motors
<hr/>					
337.5	x	50	=	16875	lost in diverter.

Thus we see that 337.5 volts are used in forcing the 50 amperes through the diverter.

Now compare the above figures with those given on next page, obtained from the same car running under identically the same conditions as before, with the exception that the controllers were of the series-parallel type. Two motors each taking 25 amperes at 162.5 volts the same as before; but the motors are in series, so the total current is only 25 amperes.

Volts. Amperes. Watts.

500 x 25 = 12500 from power house, a saving of 50 per cent.

325 x 25 = 8125 consumed by the motors.

175 x 25 = 4375 lost in diverter.

16875 Watts lost in diverter, parallel method.

4375 " " " series-parallel method.

12500 Watts saved by using the series-parallel controller ;

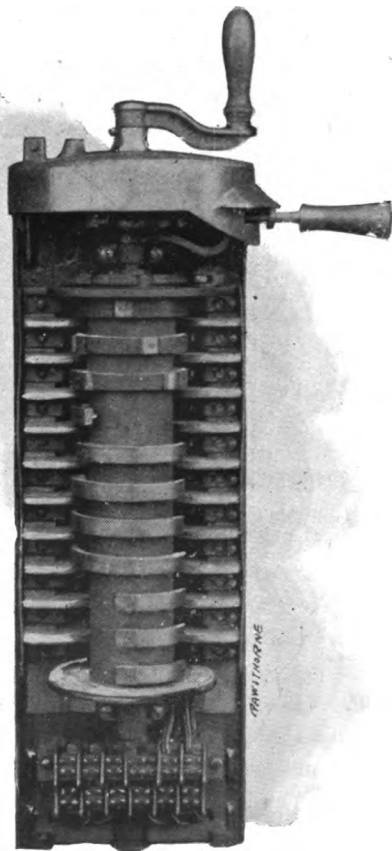

FIG. 16.—TYPE "G" SERIES-PARALLEL CONTROLLER.

enough to run another car. Of course it is understood that the above only applies to a car running on the first notch, after the car has gained some headway the controller handle is moved to the other notches and the diverter is gradually cut out. It

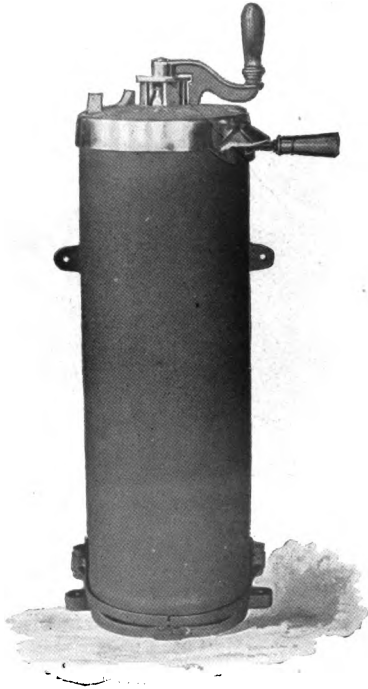

FIG. 17.—NO. 14 CONTROLLER, CLOSED.

is to be borne in mind also that when running on the last notch of a parallel controller it is as economical as the series-parallel in the same position ; in fact it is identically the same thing.

The G Controller.—The different combinations available

with this controller are given in detail in the chapter on Operation. The connections for the different combinations are made by means of multiple metal contact fingers pressing on contact rings, which are mounted upon a square steel shaft and insulated

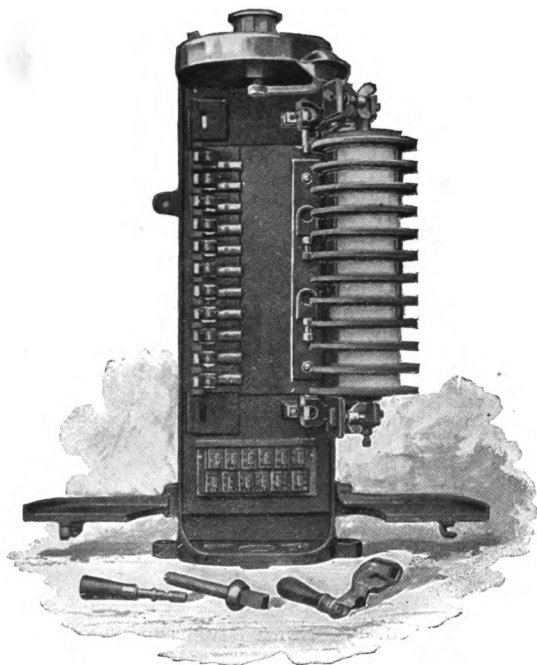

FIG. 18.—NO. 14 CONTROLLER, OPEN.

therefrom. On back of controller between the contact fingers are mounted vulcabeston partitions which project between the contact rings, thereby confining the arcs to pockets and preventing short circuits between adjacent rings and fingers. The reversing switch connections are mounted upon a vulcabeston disc, which is in

turn secured to the top plate and operated by a separate handle projecting through the side of same. All the controller terminals are securely fastened to the base and are connected to their respective contact fingers on controller back, and to reversing switch, by wires leading through the hollow double back of the controller.

The E Diverter, which accompanies the G controller, is

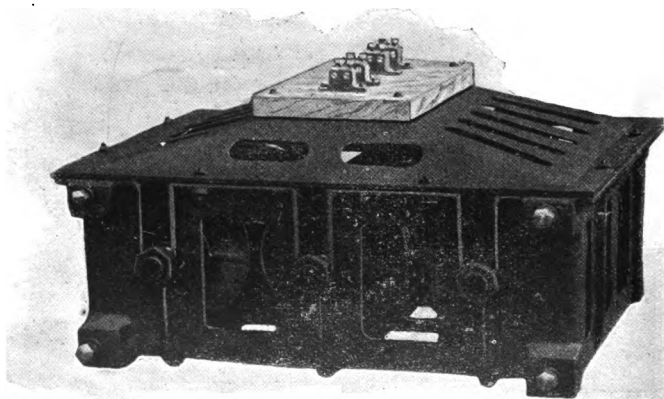

FIG. 19.—No. 7 DIVERTER.

similar to the D in construction. It has three terminals, the resistance being divided into two parts.

The No. 14 Series-Parallel Controllers is very similar in operation to type G. Both handles are provided with locking devices, which prevent their removal, except when in the "off" position. The electrical combinations made by this controller

are improved over those of the earlier types, in that the motors divide the work more equally and attain their maximum speed more smoothly. The controller drum is so constructed that it can be swung clear of the contact fingers, as shown in Fig. 18.

This provides ready access to the drum and contact fingers. The cylinder or drum is built up of thick porcelain and vulcabeston rings, the contact rings being secured to the porcelain. When this controller is used the cut-out box is unnecessary, its function being performed by the cut-out plugs mounted upon the right of the frame.

The No. 7 Diverter, which was designed to be used with the No. 14 controller, is similar in construction to those used with the D and G controllers.

The No. 28 Controller, which is also of the series-parallel type, was brought out later than the No. 14. The electrical combinations obtained with these two controllers are very similar. The No. 28, however, has been designed and constructed in more compact form, and consequently takes up less space on the car platform than the earlier types.

The No. 46 Diverter is constructed on the same lines as those previously described. For convenience in handling and mounting, however, it is built in two separate parts.

The No. 29 Controller is similar to the No. 28, both in construction and operation, except it is designed and built to control motors of a larger capacity.

The No. 47 Diverter is similar to the No. 46 in construction; the principal difference is that the iron resistance strips in the No. 47 are thicker, to provide greater current carrying capacity.

The No. 28A Controller, instead of having the porcelain rings used on the Nos. 14, 28 and 29, is built with lugs, or rings of cast iron, which are fitted directly on the square steel shaft and

insulated therefrom by a heavy mica cell. The iron lugs are faced with copper contact pieces, which make contact with the

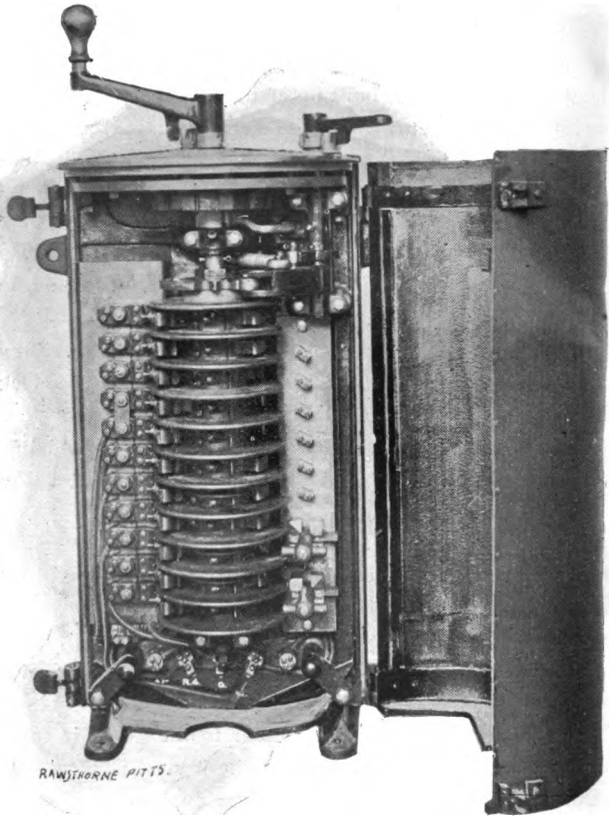

FIG. 20.—NO. 28A SERIES-PARALLEL CONTROLLER.

fingers at the side of the controller. Vulcabeston rings are used to insulate the cast iron lugs from each other. The handles are interlocking with each other, so that it is impossible to reverse

the motors without first bringing the operating handle to "off" position, nor can the operating handle be moved when the reversing handle is in the central position. The reversing handle is

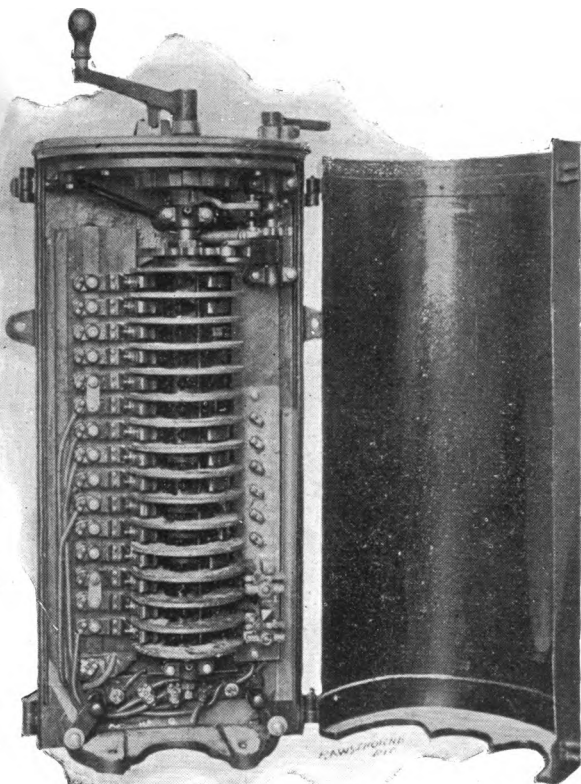

FIG. 21.—No. 38 SERIES-PARALLEL CONTROLLER.

mounted on top of controller instead of on the side as with those previously described.

This controller is also provided with a device which prevents the operating handle from being moved beyond the fourth notch when either motor is cut out.

The No. 38 Controller.—The recent demand for larger cars and higher speeds led to the design of the No. 38, 50 horse power motor, which in turn necessitated a controller of a greater capacity than those already described. The No. 38 controller, which was built to meet these requirements, is constructed on the same general plan as the 28A. The No. 38 is larger, however, than any of the other controllers mentioned, having four more contact rings than the No. 28A; these extra rings admit of greater flexibility in handling the motors.

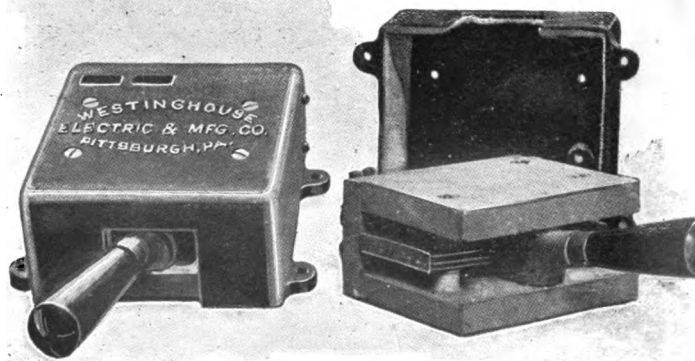

FIG. 22.—CANOPY SWITCH.

The No. 38 Diverter, which is used with the No. 38 controller, is designed and constructed on the same general plan as the Nos. 46 and 47, but is larger, and therefore, for convenience, has been divided into three separate parts.

The Canopy Switch, which is also called the platform switch, is mounted under the hood or projecting roof of the car, in order to be within easy reach of the motorman. One of these switches (see Fig. 22) is placed at each end of the car. The current passes from the trolley through both of these in series before reaching the fuse box, so that in case of emergency the current supplying the motors can be instantly cut off by simply throwing either one of the switches.

The contact pieces in these switches are surrounded by slabs of slate, and another slab of the same material extends between the two jaws, preventing destructive arcing when the switch is opened. The switch is enclosed in a cast iron box lined with asbestos. The handle projects through a slot in the iron box and the words "on" and "off" are cast on the box, the handle being thrown toward the word "on" when it is desired to close the circuit and toward "off" when the circuit is to be opened. A spring catch holds the handle securely when thrown to "off" position.

The Cut-Out Box is used only with equipments having "D" or "G" controllers. It is generally placed under one of the seats. It is not used except in case one of the motors should get out of order, when by removing a plug in the cut-out box the defective motor can be cut out of the circuit and the car operated with the remaining motor. Wires pass through the cut-out box from one controller to the other and make electrical contact with terminals in the centre of the box. When the plugs are in position these terminals are placed in electrical contact with four others on each side of the box. Four wires from the terminals on one side lead to motor No. 1, and similarly the four terminals on the other side are connected to motor No. 2. So that if the plug for No. 1 motor is out no current can reach the motor, and motor No. 2 will have to propel the car alone.

The cut out box is replaced in equipments having other controllers than the "D" or "G" by two plugs on the controller, to

the right of the cylinder. The upper plug, on both controllers, cuts out the same motor, which we will for convenience call No. 1. The motorman should find out which is No. 1 motor on his car, so that in case of trouble he will be able to remove the proper cut-out plug without wasting time experimenting.

The Lamp Circuit of an ordinary electric car usually consists of five 100-volt incandescant lamps in series. The wiring for the lights should always be done while the car body is being built; the wires being concealed in the moulding where they will not be subject to any wear from moving windows or doors. No. 16 copper wire is usually employed for this purpose. A 100-volt 16 candle power lamp requires about one-half an ampere. We have 500 volts on a railway circuit, and each lamp has a resistance of about 200 ohms or 1000 ohms for the five lamps.

A two point switch is provided for the lighting circuit and usually placed just inside the car door, so the lamps may quickly and easily be switched on and off.

The Car Fuse Box or block is a device used to protect the motors and other car apparatus from being burned out or otherwise injured by dangerously large currents. The fuse provided with the block is simply a piece of copper wire of such a size that in case the current becomes too large for safety, the wire will melt and thus open the circuit.

The block used at present by the Westinghouse Co. consists of a small wooden box lined with asbestos cloth, in order to make it fire proof. Inside the box is a small lignum vitæ block, provided with two terminals supplied with thumb screws; these terminals are connected to the main trolley circuit. A groove extends around the block from one terminal to the other and the fuse wire is placed in this groove. The total current supplied to the motors must pass through the fuse.

The block must be removed while putting in a new fuse, so there is no danger of receiving a shock in case the motorman has

forgotten to open the canopy switch. The fuse block is usually mounted directly under the platform of car, although it may be placed wherever is most convenient. If placed under the car it should be near one side, so that a new fuse can be inserted quickly and without getting under the car. Extra fuses should always be carried. The size of fuse to use depends on the capacity of the motors and the conditions of the road. The fuse is not intended to blow with any ordinary or heavy load on the motors, but is

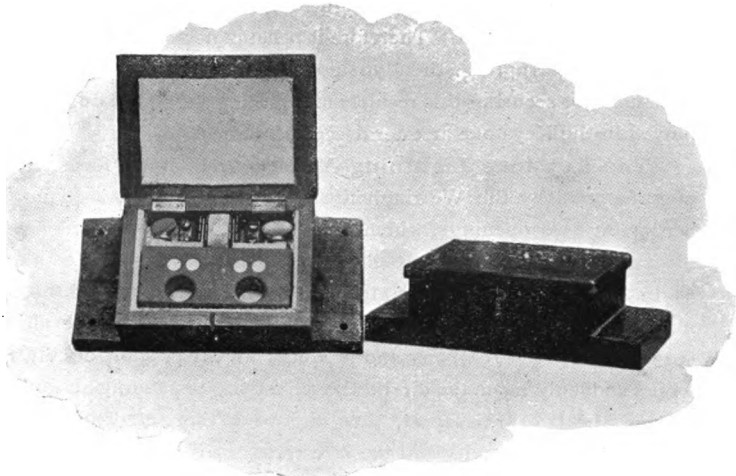

FIG. 23.—CAR FUSE BOX.

simply used as a precaution. Ordinarily, with 20 or 25 horse power motors a piece of No. 14 copper wire may be used; with a 30 horse power equipment No. 12 wire is usually employed.

The Lightning Arrester is an exceedingly important part of every car equipment, and no car motor should be unprotected by one of these valuable devices, which should be placed

under the car. The function of an arrester is not, as one might suppose from its name, to arrest or stop the lightning, but simply to provide a path to conduct the lightning to earth, and thus prevent it from making its own path through the electrical apparatus to ground.

It has long been known that lightning discharges from overhead wires pass more readily to ground over a small air gap than through coils, or even straight lengths, of wire. A great difficulty, however, arose with air gap arresters, owing to the fact that the dynamo current followed the lightning discharge, and thus established a short circuit. Therefore it became necessary to devise means of interrupting the dynamo current. Various methods were used for securing this result, among them being the one employed in the Keystone arrester described below.

The Keystone Lightning Arrester, which was formerly manufactured by the Westinghouse Co., comprises an air chamber having two openings, which are kept closed by light movable arms, with carbon tips attached. The carbons are adjusted so as to be kept about one-sixteenth of an inch apart inside air chamber. When a discharge occurs it jumps across the air space between the carbons and produces an arc or short circuit, which suddenly heats the air in the chamber, expanding it and driving the two arms apart, thus rupturing the arc. The arms then fall back by gravity and the arrester is ready for another discharge.

The Non-Arching Railway Lightning Arrester.—Experience has demonstrated that the arc rupturing devices are uncertain and unreliable. The electrodes, or tips, on each side of the air gap frequently become fused or melted together, rendering the arrester useless; hence, it is evident that an arrester which prevents the dynamo current from following the lightning discharge and thus renders an arc rupturing device unnecessary, possesses great advantage over all other types. Such an arrester

has been invented by Mr. Alexander J. Wurts, of the Westinghouse Co., and it is a decided improvement over everything previously devised for the purpose.

It is known as the discriminating arrester, because it discriminates between the lightning discharge and the dynamo current, allowing the former to pass readily, while preventing the dynamo current from following. This arrester is called the Non-Arcing Railway Arrester, and is the standard type now manufactured by the Westinghouse Co. As its name implies, it is absolutely non-arcing.

The principles upon which this arrester is designed are based on the following facts.

First.—A discharge will leap over a non-conducting surface, such as glass or wood, more readily than through an equal air gap.

Second.—If a pencil mark be drawn over the non-conducting surface the discharge will take place still more readily.

Third.—In order to maintain a dynamo arc, fumes or vapors of the electrodes must be present; consequently if means are provided to prevent the formation of these vapors, there will be no arc.

The illustration (Fig. 24) shows this arrester, which consists of two metal electrodes one inch wide mounted upon a lignum vitæ block, flush with its surface. The block is provided with charred grooves as shown in the cut; there are nine of these grooves about one-sixteenth inch wide by one-thirty-second inch deep. A solid lignum vitæ block is fastened firmly over the other block, covering the grooves and the electrodes. The discharge passes between the electrodes and over the charred grooves, which act simply as an electrical crack through the air, and thus provide an easy path for the lightning. The resistance between the electrodes is over 50,000 ohms, and consequently no current leaks through.

As the second block is screwed tightly over the grooves and the metal electrodes it is impossible for conducting vapors to form; hence the arrester is non-arcing. In the illustration the arrester is shown mounted upon a marble base for station use. When used for cars the arrester is completely enclosed in a cast iron box.

The Choke Coil is a coil of heavy wire, which is connected in series with the trolley wire between the motor and the point

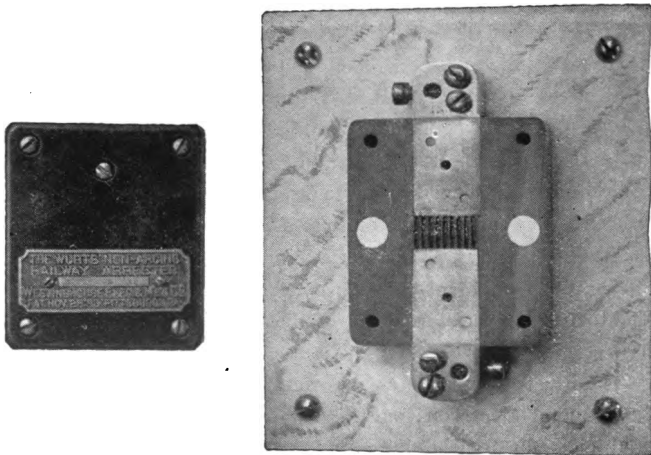

FIG. 24.—NON-ARCING RAILWAY LIGHTNING ARRESTER.

where the lightning arrester connection is made, as shown in Fig. 25. As stated before, lightning will pass through a small air gap in preference to going through a coil of wire.

The Cables consist of the necessary wires enclosed in linen hose. These cables are made up at the factory and shipped com-

plete ready to connect up. Each wire is supplied at the ends with small tags stamped with numbers and letters corresponding to those marked on the terminals to which the wires are to be connected. Care must be used in connecting up to see that the proper wires are placed in the various terminals. Each connection can be tested with a magneto bell if desired. The cables are supported under the car by means of leather cleats. In connecting wires from the body of the car to the motor terminals

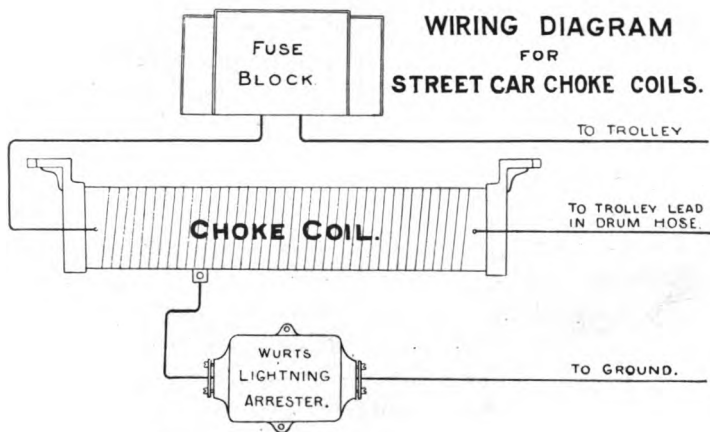

FIG. 25.

enough slack should be left to provide for making a coil of several turns just before reaching the motor; this secures flexibility and prevents the wires from being broken by the motion of the car body and the truck. The ends of the wires should have the insulation completely removed and the different strands should be soldered together before being placed in the terminals; this gives

better electrical contact and prevents the wires from breaking off easily. The tags should always be left on, so that if the wires are ever disconnected they may be replaced without difficulty.

The Trolley, although an important part of the equipment, is too familiar to require any description.

CHAPTER IV.

OPERATION OF THE CAR EQUIPMENT.

The importance and necessity of all employes becoming thoroughly familiar with the apparatus they are handling cannot be over estimated. The promptness and intelligence with which accidents or emergencies of any kind are met by the employes has much to do with the success of the road.

Superintendents and inspectors should thoroughly understand every detail of the system by which their road is operated; this necessarily includes a knowledge of the car wiring, which differs somewhat, depending upon which type of controller is employed, and also differs slightly, according to the construction of the cars.

Superintendents should be, and usually are, provided with blue-prints showing the wiring of their cars. These diagrams should show clearly where every wire starts and where it ends, so that the current can be traced from the trolley to the ground.

As, at first sight, the average railway employe regards a car wiring diagram as too complicated for his comprehension, it might be well if the superintendent would permit someone who understands the matter to explain the connections to the men, tracing out on the diagram the path of the current as it passes from the trolley through the various devices to the ground.

This plan would answer in the case of small roads, but would hardly be practicable with roads employing a large number of men.

Although the motors are the most important part of a street car equipment, the controller is the device with which motormen are directly concerned when operating the car, for it is by means

of the controlling apparatus that the speed of the car is regulated, and, in fact, unless something gets out of order some motormen, unfortunately, never see the motors. Therefore, we will first describe the operation of the controllers.

We will begin by explaining the meaning of the letters and figures stamped on the various terminals of the motors, controllers, diverters, and cut-out boxes, and also on the small tags attached to the ends of the wires.

+	signifies a positive terminal.
—	“ “ negative “
F	“ “ field “
A	“ “ an armature “
G	“ “ a ground “
T	“ “ trolley “



FIG. 26.

When the letters F and A are followed by the figures 1 or 2, they refer to the number of the motor; for instance, F_2+ and A_1- mean, respectively, positive terminal of field on motor No. 2 and negative terminal of armature on motor No. 1.

When the letters F and A are used without being followed by the figures 1 or 2, they are to be understood as referring to both motors; for example, on the D controller the terminal marked A refers to the armature terminals of both motors.

The terminals of the diverters are also stamped with figures to distinguish them apart; for instance, in the D diverter the resistance is divided into four parts and the terminals are stamped with the figures as given in the diagram—Fig. 26.

In the latter diverters the terminals are marked R1, R2, etc. instead of 1-|, 1-2-|, etc.

D Controller.—This, as previously stated, is a parallel controller, having 10 running positions or notches, five on one side of the central or "off" position and five on the other. One set of these notches is used when the car is propelled forward and the other set when the car is operated in the reverse direction.

To Start the Car Forward. Throw the controller handle to the first notch toward the left. Be sure that the notched wheel catches; don't merely move the handle far enough to make contact. As increased speed is desired throw the handle successively to the second, third, fourth, and fifth notches; a momentary pause should be made on each notch.

To Stop the Car.—Bring the handle back with a continuous motion to the "off" position; care must be taken not to allow the handle to swing past the central position, as this would reverse the direction of the current through the armature, thereby bringing the car to a sudden stop and causing a severe strain on motors and gears.

To Reduce Speed.—The handle should be brought back to "off" position, as explained in the previous paragraph and then moved forward to the notch which gives the required speed.

To Reverse the Direction of the Car.—Bring handle to the "off" position and apply the brakes until car stops; then release brake and start car exactly as before, only revolve the controller handle in the opposite direction; that is, to the right.

The electrical combinations of the motors and diverters for each position of the "D" controller are as follows:

First Notch.—The two motors are in parallel and the whole diverter resistance is in series with them.

Second Notch.—Same as in first position, only the portion of diverter resistance between the terminals 1-| and 1-2-| has been short circuited.

Third Notch.—Same as above, with the exception that more resistance has been short circuited.

Fourth Notch.—Here we have all the diverter resistance between 1-| and 3-4-| short circuited and only the portion between 3-4-| and 4-| left in the circuit.

Fifth Notch.—Here the entire diverter resistance is cut out and the motors receive the full voltage of the line, giving maximum speed and the highest efficiency. This notch should, therefore, be used whenever possible. Thus it is clear that the only change made by the different positions of controller, is to gradually cut out the diverter resistance, the motors remaining in parallel throughout; this is the reason the "D" is called a parallel type controller

The G Controller, as explained before, is of the series-parallel type, having two handles: one for controlling the car and one for operating the reversing switch. In order to reverse the direction of rotation of a series wound motor it is only necessary to reverse the direction in which the current flows through the field coils or the armature. In the G controller the reversing switch changes the direction of the current through the armatures. This switch is provided with three notches; the central position cuts off all current, the other two control the direction of the car. The reversing handle should not be moved, except when the operating handle is in the "off" position. The first G controllers manufactured had ten notches in the ratchet wheel. The first three and the last three are running notches, the other four should be passed over slowly without making a pause. In the later G controller the ratchet wheel contains the 6 running notches only. The combinations formed by the different running notches are as follows:

First Notch.—Both motors in series with the whole diverter resistance. This position is used for starting and can also be used when very slow speed is desired in crowded streets.

Second Notch.—One-half the diverter resistance has been short circuited, giving higher speed than the previous notch.

Third Notch.—Here all the resistance in the diverter is cut out, and motors are in series, receiving full voltage on the line. This is an economical running notch for moderate speed.

Fourth Notch.—Here the two motors are in parallel, the whole diverter resistance being in series with one of them.

Fifth Notch.—Same as above, only one-half the resistance has been cut out, producing slightly higher speed. This and the previous notch should not be used for long periods or for heavy work.

Sixth Notch.—Here we have both motors in parallel and no diverter resistance in use. This is the running notch for greatest speed and highest efficiency.

To start the car, see that the controller handles are at "off" position. Throw the reversing switch handle forward or backward, according as it is desired to move forward or backward. Throw the controlling handle to first notch and the car will start.

To stop the car, bring the operating handle to the "off" position with a continuous movement and apply the brakes. Do not move the reversing handle.

To reverse the car, bring operating handle to "off" position, then throw the reversing handle completely over and start the car with controlling handle as before.

If it becomes necessary to run the car with one motor alone it will not start with controller on first notch, as this would leave an open circuit. When motor No. 1 is used alone, the car will start when controller handle is on 8th, and reaches full speed on 10th, position. If motor No. 2 is operated alone, it starts on 4th, and is on full at the 6th, position.

The No. 14 Controller is operated in a similar manner to the "G." It has six running notches. The reversing switch

changes the connections so as to reverse the direction of the current in the field coils.

The combinations formed by the different notches are as follows:

First Notch.—Both motors and the two halves of the diverter are in series here, slow speed; this corresponds to the same notch on "G" controller.

Second Notch.—Motors the same as above; the portion of diverter between terminals R₂ and R₁ has been short-circuited, giving higher speed and less loss in diverter.

Third Notch.—Both motors in series and receiving the full line pressure, the entire diverter being short-circuited. This gives moderate speed and no diverter losses; the same combination as obtained with the third notch on the "G" controller.

Fourth Notch.—Each motor in series with one-half the diverter, and both combinations in parallel with each other, giving higher speed than notch 3.

Fifth Notch.—One motor across the line receiving full voltage. The other in series with one-half the diverter resistance and in parallel with the first motor.

Sixth Notch.—Both motors in parallel, each receiving full voltage; maximum speed; exactly the same result as obtained by the last notch of the "G" controller.

The reader will note that the cut-out box is dispensed with in this equipment and two small cut out plugs substituted on the right hand side of controller. In case motor No 1 is to be cut out of circuit the upper plug is removed. Similarly the lower plug cuts out motor No. 2.

With the No. 14 controller, when running with either motor alone, car starts on the fourth notch.

The No. 28 and 29 Controllers.—As explained in Chapter III., these controllers are similar in construction. The No. 28 is used for 25 and 30 horse power equipments, while the No. 29 is

used with motors of larger capacity. The combinations obtained by the different notches are as follows:

First Notch.—Both motors in series with all the diverter resistance, slowest speed.

Second Notch.—Same as above, except part of diverter resistance is cut out; slightly increased speed.

Third Notch —Both motors in series, with ^{no} diverter resistance, corresponding to the third notch of the 14 controller.

Fourth Notch.—Part of the diverter resistance in series with both motors, which are in multiple.

Fifth Notch.—Part of the diverter resistance cut out, leaving both motors in multiple.

Sixth Notch.—All the diverter resistance cut out, leaving both motors in multiple, receiving full line voltage; same as last notch on the G or 14 controller.

With either motor alone, the car starts on the fourth notch.

Throwing the reversing switch on the No. 28 or 29 controller changes direction in which the current passes through the field coils.

The No. 28A Controller has seven running notches instead of six. On the first notch the whole diverter resistance is in series with both motors. The resistance is gradually cut out, until at the fourth notch we have the motors in series alone. This corresponds to the combination obtained on the third notch of the No. 28 controller. The fifth notch gives both motors in parallel with a portion of the diverter resistance in the circuit. Part of this resistance is cut out on the sixth notch, and the seventh notch gives two motors in parallel without any diverter; this corresponds to the sixth notch of the No. 28 and 29, and is the running notch for highest speed.

With either motor cut out the car starts on the first notch and is on full at the fourth. As explained in Chapter I I., the operat-

ing handle cannot be moved beyond the fourth notch when either motor has been cut out by means of the cut-out plugs.

The No. 38 Controller is almost identical in operation to the 28A. There are eight running notches, however, instead of seven; four of these throw the motors in series and the other four give the parallel combination. As usual, the first notch gives the motors in series with all the diverter resistance. The fourth notch leaves the motors in series without any diverter. The fifth notch gives the parallel combination, with part of the diverter in the circuit; this resistance is gradually cut out until on the eighth notch we have the two motors in parallel receiving the full line voltage.

The cut-out plugs on the 38 controller are operated exactly as on the 28A. With one motor cut out the car starts on the first notch and is on full at the fourth.

General Instructions for Operation.

First.—In going around curves and entering turnouts the conductor should be standing on the rear platform with his hand on the trolley rope.

Second.—Slow speed should be use in going around all curves and crossing streets and railroads and in passing all rough places.

Third.—Do not stop on heavy grades or curves if it can be avoided. This will relieve the gears and motors from severe strains.

Fourth.—Cut off current in passing all overhead switches.

Fifth.—Run slowly through all flooded places; if possible, with current shut off. Never allow water to drip from the clothing upon the motors while examing them.

Sixth.—Any electrical trouble may be quickly stopped by throwing the canopy switch or pulling the trolley down.

Seventh.—Any defects in track or overhead line should be promptly reported.

Eighth.—In going down grade do not let car get beyond control. Trolley should be kept on wire, as it may be necessary to stop suddenly, and if the brakes fail the motor could be reversed.

Ninth.—If the car wheels slip when going up grade, use sand. Where cars are run on steep grades they should always be provided with reliable sand boxes.

Tenth.—If current is shut off at the power station while car is running, owing to the operation of the circuit breaker or from any other cause, bring the controller to off position, then turn on the light circuit and wait until the lamps reach their customary brightness, then start the car as usual. Do not leave controller on first or any other running notch while waiting for the current.

Eleventh.—Never reverse the motors with the brakes on. Never reverse while car is in motion, except to prevent accidents. In such cases apply the reversed power gradually; by reversing too suddenly the fuse may be blown or the gears stripped.

Trolley.

First.—Never place trolley on the wire unless both controllers are at off position.

Second.—When trolley leaves the wire the conductor should signal the motorman to stop; after replacing the trolley he should signal to go ahead. The motorman should throw the controller handle to off position when the trolley jumps, and keep it there until he receives the conductor's signal.

Third.—If trolley leaves the line frequently or if any loose motion is noticed or if there is any flashing between trolley and wire, when running fast on a straight track, report the trouble at once.

Fourth.—Never run car with trolley pole in wrong direction, or the result, sooner or later, will be to bend or break the pole or tear down some of the overhead construction.

Fifth.—When car is run into shed, always throw canopy

switch to off position. Remove trolley wheel from the wire and leave the pole in such a position as to relieve the trolley springs of their tension.

Sixth.—When handling any of the car apparatus it is always safer to remove the trolley wheel from the wire.

Lamp Circuit.—The lamps may sometimes refuse to light. The trouble will probably be due to one of the following causes: A broken or burned out lamp, poor contact between one of the lamps and its socket, poor contact in the switch, a loose or broken wire or a blown fuse. The remedies are: To replace the defective lamp with a new one, to try every lamp pushing it more firmly into the socket, to remove the cover of switch and tighten contacts or to replace fuse. If the trouble is not found to be due to any of these causes it should be reported to the car inspector, who should then test out the circuit, as explained in Chapter VI.

A lamp should never be removed from its socket while the current is on, as the arc is liable to jump from the centre contact to the side contact and burn out the socket.

Finally—Keep everything clean and in good order. If anything on the line or in the car equipment is not in proper condition, report the defect to the car inspector or superintendent at once.

CHAPTER V.

INSPECTION.

Every inspector should be required to thoroughly familiarize himself with the details of the system with which the cars are equipped and be able to locate faults and apply the necessary remedy quickly and successfully. If anything is out of order it should be repaired at once and not allowed to become worse day by day until the car refuses to move. All nuts, bolts, and wire connections should be watched carefully and everything should be kept screwed up tight.

The wire connections on lightning arresters, trolleys, fuse boxes, diverters, &c., should be inspected frequently. Poor contact at any of the connections will result in heat being developed at that point and the wires may be burned through. Not only this, but the production of heat means that so much power is being wasted, and this results in an actual financial loss to the company operating the line.

In addition to the inspection mentioned above, about every six weeks the cars should be run over the pit and the motors thoroughly cleaned and examined.

New Cars.—When starting a new car try the motors one at a time to see whether the revolution of the controller handle moves car in same direction with each motor; if not, cross the armature or field wires on one of the motors.

Open Circuit.—To find an open circuit in car wiring, try both controllers. If one works the fault is in the other one. If neither works the trouble is probably not in the controllers. Tie down the trolley and throw one controller handle to first notch; now hold one wire from a magneto bell on the iron work of truck

or motor and touch with the other wire the ground connection of the controller. If this rings, the ground connection is all right. Take connections in regular order and when you come to one that will not ring you have located the trouble; trace all wires from that point. If all points ring, bring the controller to "off" position and try the same method with the other controller. If both are found to be correct look for a broken or loose connection between trolley base and the fuse block.

The Commutator should always be kept clean and the surface as true as possible. Remove the brushes, then use sand paper while armature is running with that motor cut out. If the commutator becomes rough or out of true it should be placed in a lathe and turned down. In this case do not cut any deeper than necessary and do not allow the tool to go to the end of the bars but leave a narrow ridge at the outer end. Finish with fine sand paper. A very little paraffine rubbed on the commutator is sometimes beneficial, but as long as the commutator shows a good gloss it should be left alone.

The Brushes should make good contact with the commutator; they should not be allowed to wear too short, for in this case the springs will not give proper pressure and the brushes will make poor contact. Take out each brush in order to ascertain whether it moves freely in its holder. In replacing brushes be sure to place each one in the same holder from which it was removed and have the same side up. They will make better contact if put back in exactly the same position as that in which they were found.

Brush Holders should never be permitted to become loose and they should be adjusted as the commutator wears down, so that they are not more than one-quarter inch away from surface of the commutator.

Controllers —The covers of the controlling stands should be removed and the contacts examined frequently. The contact

strips and blocks should be cleaned and polished whenever rough, and they should be very slightly moistened with tallow to prevent them from becoming dry, and cutting. See that the flat-headed screws, which hold the contact blocks and contact tips, are screwed tight. After considerable use the removable tips on the contact rings, and the contact blocks themselves, will become so worn that they should be replaced with new ones. The springs should all be of about the same strength, and should press the contact blocks firmly against the rings on the cylinder. The notched plate or ratchet wheel at the top of cylinder, as well as the two bearings of the cylinder, should be carefully lubricated; but very little oil should be used and care should be taken not to allow it to run on cylinder. The connections at the bottom and side of controlling stands should be examined occasionally to make sure that they are all secure.

Bearings.—In case the armature bearings are much worn the armature will rub against the pole pieces and may be seriously damaged. Watch the clearance of the armature carefully, and if armature is found to be approaching the pole pieces too closely put in new bushings. Loose bearings on the main axle may cause gears to break, for the gear is fastened to the car axle and the pinion to the motor, and a loose axle bearing will throw them out of line, and may twist them to such an extent as to cause the teeth to break. The four grease boxes on the motor need careful attention; plenty of lubricating grease should be used. The bearings must never be permitted to get more than slightly warm. Every night the grease should be stirred up and a little oil mixed with it if necessary; that is, if the grease is at all heavy. Take out the copper feed rod and poke the grease down into the bearing with it, after which replace rod and cover, making certain that the rod is inserted in the hole in the top bearing and rests on the shaft. When removing covers do not allow sand or mud to get into the boxes. Occasionally all the grease should be taken out

and the boxes washed with gasoline and a small quantity allowed to run through the bearings. This will cut out any grease which may have become caked in the grooves of the bearings.

Gears and Pinions will last a long time if a sufficient quantity of lubricant is kept in the casing, but an examination should be made occasionally to see how much they have worn and whether all bolts are tight. Loose motion of the pinions may be taken up by means of the nut on end of shaft. The pinion can be driven tightly on the shaft, owing to the tapering pinion seat, by tapping it with a hammer. It is very important that the pinion and gear should be absolutely tight on shaft and axle. If there is any motion it will probably be found to be due to the wearing of key, or feather, and a new one should be provided. Any noise which appears to come from the gears should be investigated at once. It may be due to worn keys, worn out gears, or to some hard object having become wedged between the teeth. Never run the car when it is making any noise of this kind.

Gear Cases should be examined and a small quantity of grease added when necessary. The amount of grease in each casing should be sufficient to keep the gears thoroughly oiled. By removing the cover of the opening at the top of casing it may be seen whether the gears are dry or not. When putting in fresh grease be very careful to have it free from foreign substances, and when a gear casing has been removed for any reason keep sand and mud out of it; a nail or bolt dropped in the casing might cause the loss of a gear or pinion. Casings should not be permitted to become loose, but should be kept tightly bolted together and to the motor, using lock nuts or washers.

The Brakes should be so adjusted that the shoes do not bind on the wheels when the brakes are not set. To run a car with tight brake shoes means a waste of power and an unnecessary load on the motors. It is of great importance to keep the brake apparatus in good working order; therefore the entire

mechanism should be closely examined. If cars are operated on heavy grades they should be supplied with sand and a reliable sand box.

Trolley.—The life of a trolley wheel depends on the quality of the metal of which it is composed and upon the number of miles it travels. New wheels should be put in as soon as the wear of the old ones is sufficient to cause them to make a rattling noise when running and to flash badly when passing the trolley supports. Wheels should be oiled every night or morning and the motormen should be instructed to oil them during the day if necessary. The more frequent they are oiled the longer they will last. The tension of the springs in the trolley base should be sufficient to keep trolley wheel pressed firmly against the wire at any speed which the car may reach. If there is a flashing produced between the trolley wheel and the wire when car is running at high speed, it is probably caused by the springs being too weak, and they should be tightened.

Lightning Arresters—In case the Keystone arresters are used, they should be examined occasionally to make sure that the swinging arms pass freely through the holes into the air chamber and that the carbon tips approach each other to within one-sixteenth of an inch. With the non arcing lightning arrester it will only be necessary to see that the connections are tight. A ground cable is furnished with each arrester and should be connected directly to ground plug on the motors without any kinks or turns.

Finally.—It cannot be too strongly emphasized that electric car motors have a very hard duty to perform, therefore it is absolutely essential that every part of the apparatus should receive careful inspection and be kept clean and in proper condition.

CHAPTER VI.

HOW TO LOCATE AND REMEDY FAULTS.

It is obviously almost impossible to give complete directions for locating and remedying every fault that may occur in the operation of street car apparatus. Several causes of trouble and the methods of remedying the same have already been mentioned in chapters IV. and V. on Operation and Inspection. In the present chapter will be found an explanation of a few more difficulties which car employes should be capable of dealing with promptly and successfully. Chapter VII. on Repairs should also be consulted in this connection.

If Car Fails to Start, try the following until the trouble is located:

First.—Throw on lamp circuit; if the lamps light up, the trolley and ground wires are all right.

Second.—Try controller and if lights go down or out the difficulty is probably due to poor contact between wheels and rails, or the section of track on which car is standing may be "dead"

Third.—Try both controllers; if one works successfully the trouble is probably due to an open circuit in the other; pull down the trolley, remove the controller cover and examine the tips, fingers and connecting wires.

Fourth.—See that both motor cut outs are in place.

Fifth.—See if fuse has blown. If so throw canopy switch and put in a new one.

Sixth.—Examine the brushes of motors to see if they are not broken and that they make good contact.

Seventh.—If car is on a dirty rail, make connection with a piece of insulated wire between wheel and track. The rail may

be "dead;" that is, not in good electrical contact with the rest of track. In that case make contact between the wheel and next rail; break connection with the wheel first or you may receive a shock.

Eighth.—In winter ice on the trolley line sometimes prevents the car from starting.

Sparking at the Brushes.—If armature, commutator, brush and brush holder are in good condition no sparking will be noticed. If there is any sparking it may be taken as an indication that something is wrong. Various causes of sparking and their remedies are as follows:

First.—Brushes may not be bearing sufficiently hard upon the commutator. Increase the pressure exerted by the spring.

Second.—Brushes may be burned or broken so that they do not fit closely upon the commutator. Renew the brushes or sand paper them down to a good surface.

Third.—Brushes may be welded to their holder. Remove and clean.

Fourth.—A commutator may be dirty, oily or worn out. Sand paper; or renew if actually worn out.

Fifth.—Commutator having a flat bar, or one that projects beyond the others or is loose, will cause sparking and blackening. Put the armature in a lathe and take off a light cut or smooth down with a file. Polish with fine sand paper.

A steady flare at the commutator may be due to:

First.—Open circuit in an armature will continuously produce a greenish flash that will appear to run around the commutator. This is detected by the scarring of the commutator at two points diametrically opposite. If allowed to go on for any length of time the commutator bars, to which the ends of the open circuited coil are attached, will gradually burn down flat, and the insulation between them and the adjacent bars will be partially destroyed. The marks on the commutator serve to show

which coil has the open circuit. The best way to remedy this trouble is by replacing the defective coil with a new one, but temporary repairs may be made by putting in a "jumper." To do this connect the two adjacent burned bars by arching solder across. It is only necessary to put in one jumper for each open circuit.

Second.—Short circuit in an armature will be made evident either by the fuse blowing or by a jerky motion of the car. Test out and correct.

Third.—A weak magnetic field, caused by short circuit, or improperly connected field coils will produce a steady flare. A short circuit in the field coils may be found by a voltmeter, noting the "drop" or difference of potential across the terminals of the coils; the current being kept constant while the test is being made.

Incandescent Lamps.—The lamps in the car will burn out; that is, the carbon filament will break after a longer or shorter time. They should then be replaced with new ones.

In case the lamps in a car refuse to light examine each one to see that the filaments are not broken; also that each lamp makes good contact in its socket. Examine switch for loose connection or a blown fuse. If the fault is not found in this way take a magnet to bell and ring from each socket to the next, beginning at the one on the front platform, then going to the cluster in the middle of the car and then to the one on the rear platform. This will locate the fault between two lamps, and these sockets should be carefully examined; and then, if necessary, examine the wiring between them. The trouble may be that the light circuit wire has broken off where it connects with the trolley or ground wires or at some other point.

If the Brakes Fail to Operate the car may be stopped by the motors in two ways; first, by reversing the direction of cur-

rent in the field as follows. (If the "G" controller is used the current will be reversed in the armatures).

First.—See that the controller handle is at "off."

Second,—Reverse the reversing switch.

Third.—Throw controller handle around to first or second notch; never beyond.

The second method can be used whether trolley is on or of the wire, as follows:

First. See that the controller is "off."

Second.—Throw canopy switch to "off."

Third.—Reverse the reversing switch."

Fourth.—The controller handle should now be brought to last notch and left there.

Either of these methods produces great strain on the motors and should not be used except in cases of emergency. To stop a car running away on a down grade use the second method.

Grounds.—A grounded field or armature coil will generally blow the fuse and render the car useless until repaired. (See Chapter VII.).

Bucking —If, after running all right, a car suddenly begins to run with jerky motion, examine the motors at once; this trouble is usually the result of ground or short circuit in field or armature. The injured motor can generally be located by the smell of burning insulation, which can be detected when the trap door is raised. Cut out the defective motor and run the car to shed with the other. Mud or water splashed on commutator, or a brush making poor contact will also sometimes cause bucking. Oil on the bearings may work along the shaft to commutator and cause a temporary ground, thus producing bucking.

Testing Motors for a Ground —A simple method of testing for ground is as follows: Connect six 100 volt incandescent lamps in series, one end being connected to trolley line through a suitable fuse and switch "A" the other end being con-

nected to ground. Between the fifth and sixth lamps, from the trolley end, insert a switch "B." Tap the circuit between the fifth lamp and switch "B" with a test line long enough to reach inside the cars to the motors. Also tap the ground connection with a test line. Now, when switch "B" is open, there will be approximately 500 volts between the two ends of the test line. With switch "B" closed there will be about 85 volts between the ends; this is a suitable voltage for testing between commutator bars for short circuits, as explained later.

When testing for grounds leave switch "B" open; disconnect the wires leading to the motors, then touch the four motor terminals with the line from the fifth lamp and notice if the lamp lights; if ^{not} the motor is grounded.

If lamps light when armature terminals are touched there is a ground in either the armature, brush holder, terminals or leads from terminals to brush holder. Remove both brushes and test again; if lamps glow the ground is in the brush holder, terminals or leads. If lamps do not glow, touch the test wire to the commutator; if they glow now the armature is grounded.

If the lamps light when the field terminals are touched, disconnect the wires leading from one field coil to another and test each coil separately until the grounded coil is located; if none of them show a ground the trouble has probably been due to grounded connecting wires.

Motors in Parallel.—If at any time, on cars equipped with two motors running in parallel, one motor should be found to be doing more than the other, which can be detected by the fact that the armature doing the most work will be much warmer than the other and its commutator worn more, and if after investigation no loose or broken connections are found, it may be advisable to equalize the motors, as follows: Slightly separate the two field castings of the motor which runs the cooler, by inserting at the places where they join together, strips of sheet iron of, say, one

thirty-second of an inch thickness. These strips should be of the same size as the surfaces between which they are placed, and should have holes through them to allow the bolts which hold the castings together to pass through. Do not separate them too far or this motor will then do most of the work. Before trying the equalizing device be perfectly sure that the connections of both motors are correct, as trouble of this kind is generally caused by faulty connections.

CHAPTER VII.

REPAIRS, RE-WINDING ARMATURES, ETC.

The repair account is an important item to all railway companies. Motors, like all other machinery, are liable sooner or later to get out of order; consequently buyers of railway apparatus will, everything else being equal, purchase that make of apparatus which can be most easily repaired. The designers of the Westinghouse motors seem to have made special efforts to have all the parts readily accessible, as the motors are so constructed that the armatures and field coils can be easily and quickly removed for examination and repair if it becomes necessary.

To Remove a No. 3 Armature.—The manner of doing this depends largely on the facilities at hand. The writers assume that every road has a pit, over which the cars may be run when repairs are to be made. The armature may then be removed, as follows: Take off gear case and pinion; remove the end plates which are bolted to lower field castings, then insert an eye bolt in this casting; fasten one end of a rope to the eye bolt, pass the other end over the car axle and fasten to a block and tackle in the bottom of the pit, or attach it to the brake rod. After removing the bolts that hold the two halves of field together and taking out the rectangular wedge on lower hinge, lower the bottom field casting. Secure a plank in such a position that when the armature bearings are loosened the armature can be rolled out. Care must be exercised not to spring the shaft by removing either bearing while the other is tightly bolted, thus supporting the weight of the armature on one bearing alone. If a rope sling is used never put the rope around the commutator, but always support the

armature by the ends of the shaft, or a wide leather belt may be used and placed around the body of the armature.

To Remove No. 3 Field Coils.—In case a bottom field coil is injured it is only necessary to lower the bottom field casting, remove the brass plate, slip the coil off the pole piece and replace with another. If it is a top coil, remove the bolts that hold the casting together, block up the lower casting and swing the upper casting back; the coils can now be easily removed. It is not absolutely necessary to block up the lower casting but is advisable as an additional precaution.

To Remove a No. 12 Armature or Field Coil.—In this motor there is no frame between the upper and lower field casting as in the No. 3, but the armature bearings are supported on a pillow block between the two castings. The armature or field coils can be readily removed, as described in Chapter II.

To Remove Armatures or Field Coils from No. 12A, 36, or 38 Motors—Remove bolts on each side of armature bearings and lower the bottom field casting; the armature can be rolled out, as explained before. In these motors the armature bearings are fitted between the upper and lower castings, and therefore if it is desired to lower the bottom casting alone in order to remove a field coil, the armature may be prevented from dropping by specially designed iron hooks, one being placed around the armature shaft on each side of the motor; the upper ends of these hooks fit into the grease cups just above the armature bearings. If it is necessary to remove an upper field coil the armature may be lowered with the bottom casting, first locking the armature in place with the hooks, and the field coil can then be removed.

Re-Winding Armatures.—Any man of ordinary skill can usually wind and connect an armature for a street car motor. It should be understood, however, that in order to do good work it

is absolutely essential that the winder shall have practical instructions under the guidance of an experienced man.

In winding the No. 3 or the No. 12 armatures, which have the closed or unventilated type of winding, the first step after thoroughly cleaning the armature core is to place a fullerboard and mica ring, with a wooden ring glued to its outer circumference, upon each end of the shaft. These rings are pressed against the core and the shaft is wrapped with insulating tape, as shown in Fig. 27. This insulation is to prevent the coils from grounding upon the core or shaft. A fibre drift of wedge and a wooden mallet are used to drive the coils to the bottom of the slots. The coils

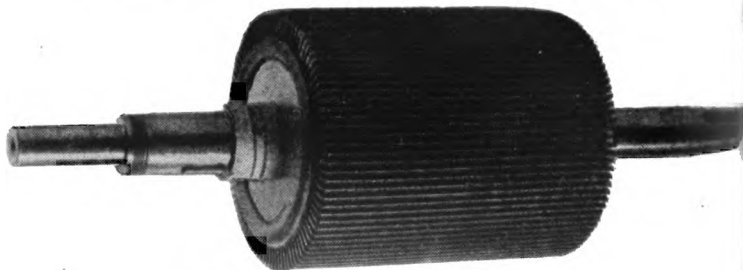

FIG. 27.—CORE OF NO. 3 ARMATURE.

are bent at the ends of the armature by a pair of hand pliers, then they are hammered into the required position by means of a fibre block and the mallet.

A piece of fullerboard $1\frac{1}{2}$ inch by 1 inch and .007 inch in thickness is placed around the coil at each end of the slot to protect the insulation from injury when the coils are bent over the ends of the core.

With the unventilated type of armature, in order to assist the winder in making an orderly arrangement at the ends, the coils are placed so as to alternately project about one-quarter of an inch more at one end than at the other. The first, third, and fifth

project more at the pinion end, while the second, fourth, and sixth project at the commutator end, and so on. A coil should never project far enough to bring the other end of the fullerboard cell within the iron core. The fullerboard cell should extend at least one-eighth of an inch beyond the iron teeth in every case.

A small piece of oiled duck is put under the last coil on each quarter whenever necessary, in order to insulate it from the first coil of the same quarter, or from the coils of the adjacent quarter. See Figs. 28 and 30.

When reading the directions for winding the ventilated types of armatures it will be noticed that each coil has one side in the lower, and the other side in the upper, layer.

The winding for the 12A, 25 horse power and the 12A, 30 horse power slow speed is the same. The 12A, 30 horse power high speed is wound differently; both windings will be described fully.

In the following detailed instructions for winding the various armatures which have been described, the winder is assumed to be standing with the commutator end of shaft on his left hand side. In the directions for connecting the terminals or leads of the coils to the commutator bars, the connector is assumed to be sitting with the commutator on his right hand side. Unless otherwise specified, all armature slots or commutator bars are supposed to be counted in a clockwise direction when facing the commutator end of the armature.

Winding the No. 3 Armature.—As stated in Chapter II, there are 95 slots in this armature. As each slot contains one side of two separate coils, there are 95 coils used; 47 of these are placed on the bottom layer and are shorter than those used on the upper layer. The insulation on one of the terminals or leads of each coil is colored black, the other end being left white in order to distinguish them when connecting. The side containing the black end should always be kept toward the winder.

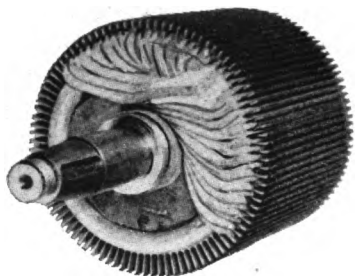

FIG. 28.

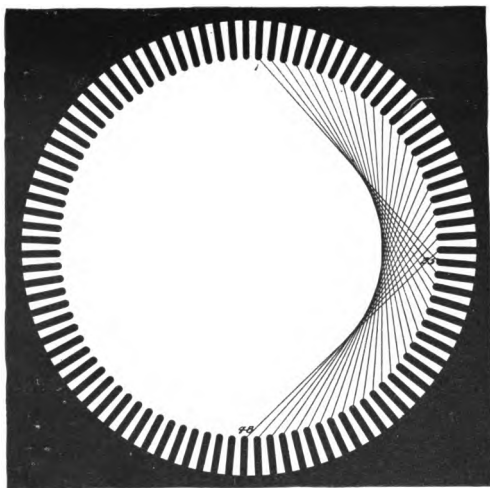

FIG. 29.

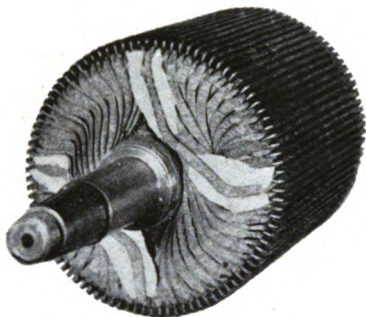

FIG. 30.

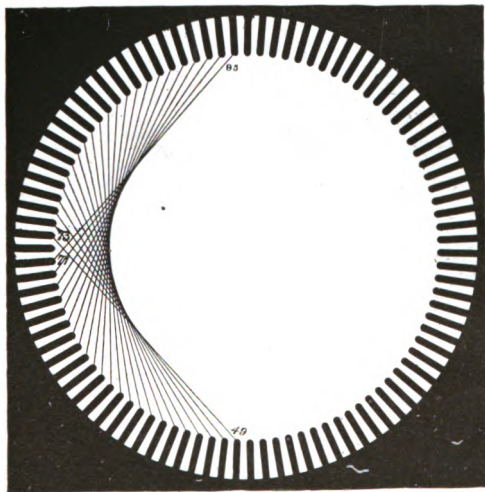

FIG. 31.

First Layer.—Start anywhere. Place the side of the coil containing the white end in slot 1, the other side in slot 25. Coil 2 is placed in slots 2 and 26; the winding continues in the same manner until 24 coils are in position. One half of the first layer or one-quarter of the armature is now complete, as shown in Figs. 28 and 29. The 25th coil is placed in slots 49 and 73, the next in 50 and 74 and so on; coil 47 going in slots 71 and 95. This completes the first layer or the second quarter of the armature. (See Figs. 30 and 31). The reader will notice that slot 72 is still empty. Before the first coil of the upper layer is placed in position the ends are covered with a blanket of oiled duck, as shown in Fig. 32, to prevent the coils of the upper layer from coming in contact with those of the lower.

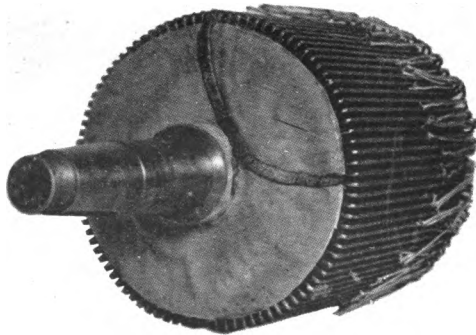

FIG. 32.

Second Layer.—The 48 larger coils constituting the upper layer are now placed upon the armature, the white end of the first coil being put in the empty slot (No. 72) and 25 slots counted off as before; this brings the black end in slot No. 1. The winder will notice that one side of this coil is in the lower, while the other side is in the upper, layer. (See Fig. 33). The second large coil

goes in slots 73 and 2; when 24 large coils are in place one half the top layer is completed. Put the next coil in slots 25 and 49, the white end in 25. The last coil is placed in slots 48 and 72, thus filling every slot and completing the winding.

Connecting a No. 3 Armature.—After the winding is finished as described above, the commutator is placed upon the shaft, being insulated from the coils by a wooden ring. Red lead is placed upon the shaft and on the inside of the commutator lock

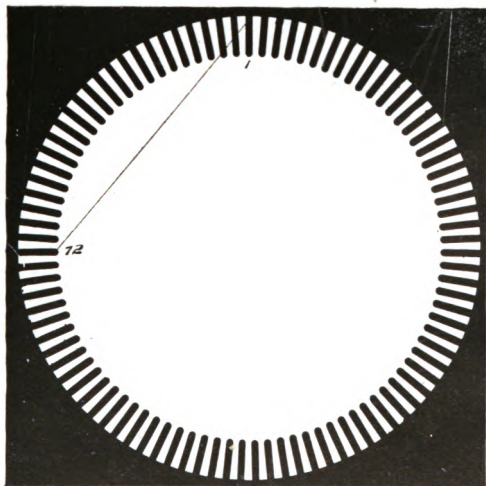

FIG. 33.

nut to prevent oil from working into the armature from the bearings. The commutator is composed of 95 segments or bars, each one being slotted to receive two wires. Start with any black wire, straighten it out over the commutator parallel to the shaft; calling the commutator bar directly under the wire No. 1, place the wire in the thirteenth bar away from you. The term "throw" is sometimes applied to the number of bars counted off in this manner.

So in this case the "throw" of the lead is 13. Place the second wire in bar 14. Continue in regular order with all the black wires, connecting one in each commutator bar, thus completing the lower layer of wires in the commutator. The leads should not be carried directly from the armature slot to the commutator bar, but should bend down over the coils and be carried partly around the shaft and then straight up to the bars.

The leads of the first layer should be covered with tape or other insulating material before placing the other leads over them. Take any one of the white leads and find the black end of the same coil; this can be done with a magneto bell or by means of the 85 volt terminals of the test line described in Chapter VI. Calling the bar which contain the black end No. 1, count in a counter clock-wise direction and place the white end in bar No. 49. It will be found that the throw of this wire is 12 or 13. The object is to make the throw of the two terminals of each coil as near equal as possible. Place the next white wire in bar 50 and continue with each wire in order in a counter clock-wise direction until the connecting is complete. Notice that the leads always swing away from the coil, so that the two ends of each coil are almost diametrically opposite on the commutator.

After the wires have been soldered to the commutator bars and the commutator turned down the oil wiper and the canvas caps are fastened in place and the armature is banded, as will be described later.

Winding a No. 12 Armature—This armature is wound and connected in the same general manner as that of the No. 3 motor, producing the same type of winding; the directions given for the No. 3 will therefore apply to a great extent to this armature also. There is a difference in the connections however, which is explained below. The armature has 47 slots, the commutator is composed of 93 bars. There are two separate coils enclosed together in one cell made up of the fullerboard and mica. There

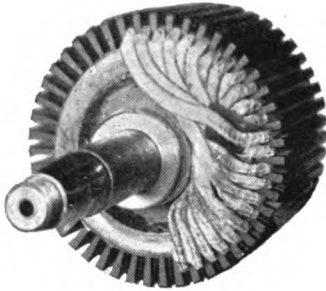

FIG. 34.

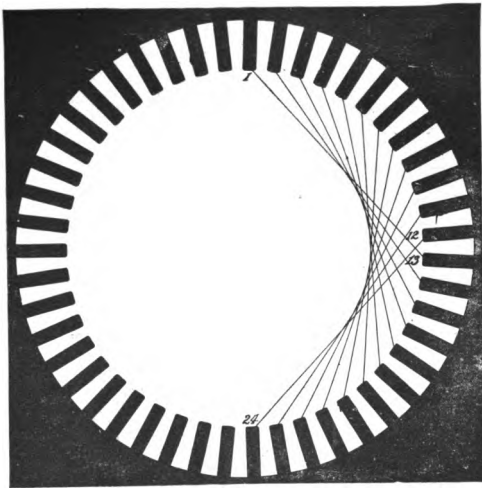

FIG. 35.

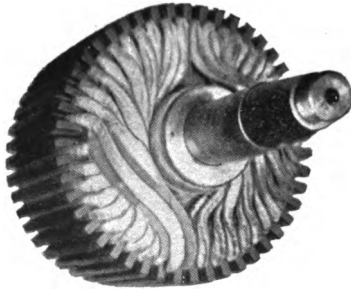

FIG. 36.

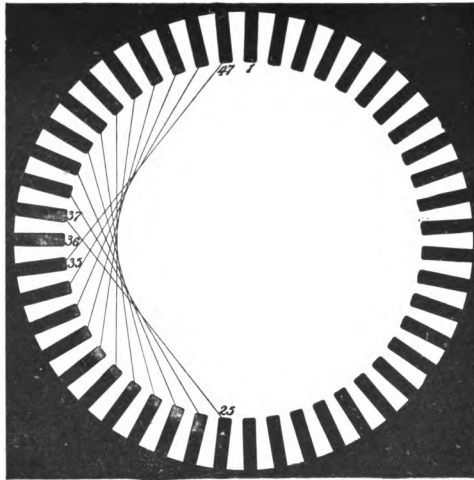

FIG. 37.

are 23 short double coils and 24 long ones used in winding one armature.

One terminal of each coil is painted black, the other being left white. When the separate coils are assembled, two in each cell, the two black ends are placed together.

First Layer.—Call the slot started with No. 1. Put the first coil in slots 13 and 1, with the black end projecting from 13. Place coil 2 in slots 14 and 2 and continue as explained in the case of No. 3 armature. When 12 coils are in position the first quarter of the armature is completed. (See Figs. 34 and 35). The thirteenth coil goes in slots 37 and 25, and so on until the twenty-third coil is placed in slots 47 and 35. (See Figs. 36 and 37). This completes the first layer; note that slot 36 is still empty.

Second Layer.—Place the first large coil in the bottom of slot 36 and top of slot 1. Coil 2 in slots 37 and 2, the last coil of this quarter in slots 47 and 12. (Figs. 38 and 39). The next coil, which is the thirteenth large one, is placed in slots 13 and 25; coil 24 in slots 24 and 36; this completes the winding.

Connecting a No. 12 Armature.—Each slot contains two cells, so there are four wires or leads protruding from each slot. Therefore we have 188 leads altogether, and as the groove in each commutator bar contains two wires this leaves two leads more than there is room for in the commutator. This is provided for by making one of the coils "dead," that is, the two ends of any one coil are cut off and taped up so that this coil is never in the circuit. It is left in the armature, however, in order to secure a perfect mechanical balance.

Detailed directions for cutting one coil out of the circuit are given below; it should be understood, however, that it makes no difference whatever which coil is cut out.

As stated before, one terminal of each coil is black and the other white; as a further precaution against errors in connecting, two of the leads from each cell are marked with red paint, so that

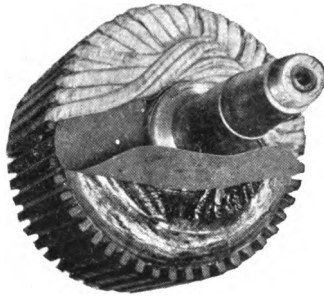

FIG. 38.

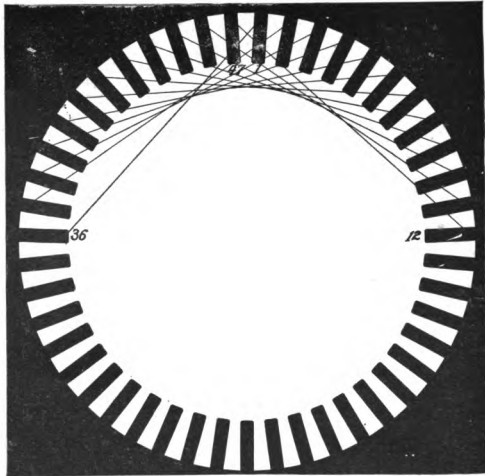

FIG. 39.

when the armature is completely wound and viewed from the commutator end the four leads from each slot will be colored as follows: A plain white and a plain black on left hand side, and a marked white and a marked black on the right.

If the white leads project from the upper cell, the black ones are from the lower cell and vice versa.

Call the slot from which projects the black terminal of the last coil in either half of the top layer, No. 1. Cut off the left hand lead, which will be plain white, from the bottom of this slot, then count to slot No. 13 in a clock-wise direction and cut off the plain black lead, which will also be on the left hand side, in this slot.

Before cutting these terminals off be sure that they belong to the same coil.

The throw for this armature is 13; therefore counting the commutator bar opposite slot 13 as bar 1, place the remaining red marked black terminal from slot 13 in bar 13.

The plain black terminal from slot 14 should go in bar 14, and the red marked black terminal from same cell in bar 15. Continue with all the black terminals in rotation, remembering that the left hand terminal of each black pair should be connected first. This completes the bottom layer in the commutator.

After the black leads are all connected use the 85 volt terminals of the test line described in Chapter VI to ascertain if the connecting is correct. Place one terminal on any white lead and the other on the commutator bar containing the black end of the same coil, then move the test line terminals to the next white lead and the next commutator bar; and continue in same manner around the commutator, testing each coil; if the sixth lamp goes out in each case, the wires have been connected in the proper order.

Now find the white end of the coil, which is connected to bar No. 1 and, throwing it in the left hand direction, connect it to bar

No. 48, counting counter clock-wise. Place the marked white terminal, from the next slot to the left, in bar No. 49, and the unmarked white terminal from the same slot in bar No. 50. Continue with all the white leads in regular order, always connecting the right hand, or marked, lead of each pair first.

Winding a 12A, 30 H. P. Armature.—This armature has 47 slots and the commutator has 93 bars. There are two separate coils assembled together in one cell as in the No. 12 armature; the terminals on one of these coils are black and those of the other are white. The coils do not have to be hammered down at the ends of the core as this is a ventilated armature; 47 coils are used and they are all of the same size.

Start anywhere. Hold the coil, or rather double coil, so that the leads are on the under side, and place it in slots 11 and 1; calling the slot nearer the winder No. 11.

If the armature is now viewed from commutator end, the coil being in position on the upper side, the right hand leads from slots 1 and 11 will be white and the left hand leads will be black.

Place the second coil in slots 12 and 2, and continue in regular order until the 47 coils are in position; the last one in slots 10 and 47. Always force the side nearer the winder to the bottom of the slot; the other side occupies the upper part of the slot, and should be driven in flush with the iron core; the upper side of the first 12 or 13 coils should only be pressed in their respective slots far enough to hold them in place at first, as they will have to be raised again in order to get the lower side of the last ten coils in position.

Connecting a 12A, 30 H. P. Armature.—First cut off and tape up the black, or left hand, leads of any one coil. Call the slot, which holds the lower side of the cell containing the dead coil, No. 1. Call the commutator bar opposite this slot No. 1 and place the remaining lead, which is white, from the bottom

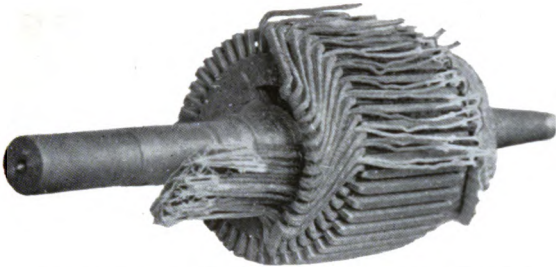

FIG. 40.—12A ARMATURE, PARTIALLY WOUND.

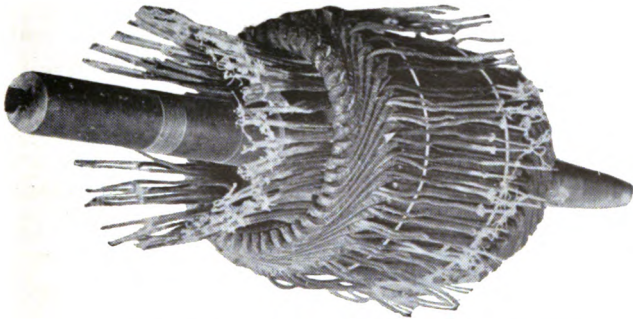

FIG. 41.—12A ARMATURE, COMPLETELY WOUND.

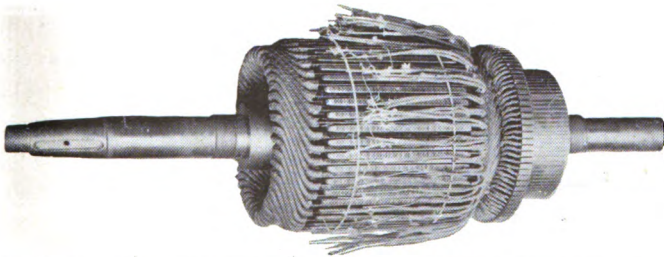

FIG. 42.—12A ARMATURE, WITH ONE LAYER CONNECTED TO COMMUTATOR.

of slot 1 in commutator bar 15, counting clock-wise as usual. The white lead from bottom of slot 47 should go in bar 14 and the black lead from same slot in bar 13. Continue around the armature in a counter clock-wise direction, taking all the lower leads in order. Always connect the white or right hand lead first. The last lead in this layer will be black from left hand side of slot 2.

The upper layer in the commutator consists of the leads projecting from the upper part of the slots and, in connecting, they are all thrown to the left. Start this layer with any white wire; first find the commutator bar which contains the other end of the same coil. Calling this bar No. 1 count in a counter clock-wise direction and place the lead in bar 48. Take all the remaining wires in rotation until the armature is completely connected.

The 12A, 25 H. P. Armature is wound and connected exactly the same as the 30 horse power with the exception that the two sides of each coil are 12 slots apart in the core instead of 11. The two leads of each coil should be 48 bars apart on the commutator just as in the 12A, 30 H. P. Care must be taken to get the throw equal on both sides of the coil.

The No. 36, 40 H. P. Armature.—The instructions given for winding and connecting the 12A, 30 will also apply to this armature; the number of slots, coils, and commutator bars being the same in both cases.

The No. 38, 50 H. P. Armature.—There are 45 slots in this armature, which is wound exactly like the No. 36; the connecting is different. Each cell contains three separate coils, making six terminals from each slot or 270 altogether. The terminals of the three coils which are assembled together in one cell are colored differently for convenience in connecting, one set being red, one black, and the other white.

The commutator has 135 bars, two leads being connected to

each bar; this disposes of the entire 270 leads; therefore there is no dead coil in this armature.

The method of connecting is practically the same as for the other ventilated armatures. The lower layer in the commutator is composed of the leads from the lower side of the coils.

Start with any armature slot, calling it No 1. Designate the commutator bar opposite that slot No. 1 and place the red terminal from slot 1 in bar 21 counting clock-wise; put the black and the white terminals from the same slot in bars 20 and 19 respectively. Continue in counter clock-wise direction until lower layer is complete, always connecting the red terminal of each group of three first, then the black, and finally the white.

To connect the upper layer start with any red terminal, call the commutator bar containing the other end of same coil No. 1, then count to bar 69 in counter clock-wise direction and connect the red wire to that bar; connect the black and white wires from same slot to the next two bars to the left, and continue in the same manner until all the terminals are connected.

Remarks on Connecting—The writers believe that any man of ordinary intelligence who has an armature core and the necessary coils before him can wind and connect the armature if the instructions given are followed closely. The work should not be done mechanically, however, but the winder should try and find the reason for each step; therefore, in connecting it is advisable to disregard the colors of the leads as much as possible and learn to connect entirely from the position of the coils in the armature. One advantage of so doing is that in case some of the lead are colored wrongly the error will be noticed and much time and trouble saved.

The following points may be of assistance in connecting:

First—Always remember that the two ends of each coil when properly connected should be almost diametrically opposite on

the commutator. The only way this can be accomplished is by swinging each lead away from its coil.

Second—In the case of the No. 3 and No. 12 armatures, which are not ventilated, the winder can usually see whether the upper part of any slot contains the right hand or the left hand side of a coil, and if it contains the right hand side he can be sure that the lower part of the same slot contains the left hand side of a coil on the lower layer, or vice versa.

By remembering this the direction in which each lead is to be thrown can be determined; for, as stated before, the leads always swing opposite to the direction in which the coils lie.

Third—When standing facing the commutator of a ventilated armature the upper part of each slot is occupied by the left hand side of a coil. Therefore, all the leads from the upper side of the slots must be thrown to the left. It naturally follows that the lower part of each slot holds the right hand side of a coil, and consequently all the leads from the lower side of the coils must be thrown to the right; otherwise the two leads from each coil will not be diametrically opposite on the commutator.

Soldering—After an armature is connected the leads must be firmly soldered into the commutator bars. That portion of each terminal which goes into the slot must be scraped clean, while being connected, otherwise it will not make good contact with the bars when soldered; this might cause the solder to melt when the motor is running and result in burning out or short circuiting the armature.

When soldering the leads into the bars, care must be exercised to prevent acid or solder from running down back of the commutator and short circuiting the segments.

Banding Armatures.—After armatures are connected and soldered they should be thoroughly dried out; in the Westinghouse factory they are sent to a drying room, which is kept at a

high temperature, and allowed to remain there for 36 hours, thus driving out any moisture that may be in the coils.

Sheets of fullerboard covered with mica are then placed around the body of the armature, being held in position, temporarily, by leather straps. The armature is then banded with No. 17 phosphor bronze wire; 22 bands, each composed of 8 turns are used on the No. 3. The bodies of the other armatures are shorter and do not require as many bands. These bands are put on with considerable tension and held together with small, metal clips. Finally, the wires composing each band are soldered firmly together, after which the completed armature is given a coat of insullac, followed by black paint.

One band is placed on each end of the ventilated armature beyond the core, on the ends of the coils. These bands are insulated from the coils by mica and heavy tape.

Tests.—When these armatures are manufactured they are each tested several times while in process of winding, connecting, and banding, by means of special alternating current testing apparatus. Each armature is also subjected to a severe running test and then another insulation test, for grounds, before being permitted to pass the inspectors.

If no other testing set is available, the testing line described in Chapter VI. may be used to advantage for this purpose.

Repairing Armatures.—The three principal difficulties that may occur to the armature winding are grounds, short circuits, and open circuits. Usually there is no trouble in locating which particular coil or coils are grounded or short circuited, as the insulation in such cases is generally burned to such an extent that the cause of the trouble is apparent. In the case of an open circuit, caused by a broken wire, the defective coil cannot usually be discovered so easily; this defect, however, can frequently be located by its effects, as will be explained later. After the defect-

ive coil or coils have been located the next question is, how to remedy the trouble.

If the armature is of the ventilated type, a new coil can usually be substituted. If the trouble is in the bottom layer of a No. 3 or No. 12 armature, especially if the coils are badly burned out in the bottom layer, it will usually pay to entirely rewind.

In many cases, however, particularly when the coil is in the upper layer, it may be removed and a new one substituted. Care must be taken to re-connect the armature wires exactly as they were before.

In some cases temporary repairs may be made by cutting the injured coil out of the circuit but leaving it undisturbed in the armature slots, as explained below.

Open Circuits.—As stated above, this trouble can often be located by its effects. An open circuit causes violent flashing each time the brushes pass over the commutator bars which contain the ends of the open circuited coil. If this flashing continues for any length of time before the car is brought in for repairs the effect is to burn the insulation between the bars containing the ends of the defective coil and two adjacent bars. These two burned spots will be on opposite sides of the commutator. The trouble can be remedied in a No. 3 armature as follows: Facing the commutator end of the armature, find one of the burned spots on commutator, call the bar on left side of the spot No. 1, the bar on the other side No. 2; continue counting the bars in a clockwise direction; if the other scar is found between bars 48 and 49 remove the upper wire in bar 1 and the lower wire in bar 49 and connect the two half empty slots with an insulated wire. If the scars are found between bars 1 and 2 and 49 and 50, take out the lower wire in bar 2 and upper wire in bar 49 and connect these bars by a piece of wire as before. The effect of this is to cut the open circuited coil out of the circuit; the ends of this coil should be well covered with insulating tape after being removed from the

commutator. The same remedy can be used in case of a grounded or short circuited coil.

From the explanation of the connections given on previous pages the reader will find that with a No. 12, 12A or 36 armature, if the burned spots on the commutator are between bars 1 and 2, and 47 and 48, he should remove upper wire in bar 1 and lower wire in bar 48. If the scars are between bars 1 and 2, and 48 and 49, remove lower wire in bar 2 and upper wire in 48.

It will be found that with the No. 38 armature if the scarred spots are between bars 1 and 2, and 68 and 69, the upper wire in bar 1 and the lower in bar 69 should be removed. If the burned spots are between bars 1 and 2, and 69 and 70, remove lower wire from bar 2 and upper one from 69.

Jumpers.—Sometimes temporary repairs may be made in the case of an open circuit by connecting two adjacent bars together with solder, thus producing an intentional short circuit. This is the simplest and quickest method of cutting a defective coil out of the circuit, but the result is that a good coil is also cut out. Two coils are always cut out, with this type of armature winding when two adjacent commutator bars are short circuited. It is only necessary to put a "jumper" on one of the scarred spots to remedy an open circuit. Of course this method of making repairs is not recommended, but may answer in case of emergency, when it is absolutely necessary to keep the car in service. For instance, on a holiday or upon any other occasion when the traffic is very heavy it will often pay to repair an armature quickly as explained above, even if it only lasts one day.

It is obvious that the above method cannot be used in the case of a grounded coil unless both ends of the coil are disconnected from the commutator and well insulated.

Field Coils.—If a field coil is grounded or short circuited in the outer layer it can frequently be easily repaired by re-insulating with tape; if, however, the trouble is in the interior of the coil the

only remedy is to remove the winding until the difficulty is found and then re-wind. When re-winding, varnish or shellac each layer of wire as the coil is built up; and be sure the coil is well dried out before placing it in a motor.

Controllers.—The most usual cause of trouble with controllers is the burning or fusing of the contact tips. On all controllers the tips of both rings and fingers are made replacable. When the tips are burned enough to raise a burr on the bearing surface, it should be filed smooth or renewed; otherwise it will result in undue heating, owing to poor contact. The most important rule to remember is always to keep good contact between all the fingers and their respective rings on the drum.

Bearings.—Worn out bushings may be re-babbitted at a small expense. The oil grooves should be cut in the new bushings exactly as they were in the old ones.

It is advisable for every road to have mandrels for babbitting axle and armature bearings. The best plan is to use a mandrel having a former for the grooves, so that when the bushings are taken out the grooves are already finished, and it is only necessary to drill the bushing for the grease and copper feed rod to pass through.

When putting in bushings, either old or new, be sure that the dowel pins are in place; if they are not the bushings may turn, so that no grease could enter the bearings.

Commutators.—When a test shows an armature to be grounded or short circuited and the armature has been taken out of motor to be repaired it sometimes happens that no defective coils can be located; that is, the trouble may be in the commutator and not in the armature winding. In such cases the commutator may be tested as follows: After the armature leads have been disconnected, use the 500 volt test line previously described. Test for ground by holding one end of line on shaft and slide the other end slowly around surface of commutator, being careful to

touch every bar. If the lamps glow, the bar upon which the test line terminal is resting at that instant is grounded and must be re-insulated from commutator shell.

Also test for short circuit between each two adjacent bars by means of the 85 volt terminals of the test line; if the sixth lamp goes out it indicates a short circuit between the two bars upon which the terminals are resting at the time; sometimes the trouble is simply due to copper dust or solder, bridging the mica insulation. If nothing of the kind is found it may be necessary to dismantle the commutator, in which case it will be necessary to put the commutator in a lathe after re-assembling, to turn it true again.

Never test between any two adjacent bars with an E. M. F. greater than 300 volts; in repair work 75 to 100 volts is a sufficient test.

Conclusion.—It is evident that a man who thoroughly understands the operation of the apparatus under his care, how to remedy difficulties when they occur, and how to act quickly and intelligently in an emergency, is a much more valuable employe than one who merely does his work mechanically.

This little book was written for the use of that large number of motormen, conductors, repair hands, inspectors, station men and others, who, while generally willing to embrace every opportunity to increase their knowledge of the apparatus they are handling, and consequently their usefulness to their employers, too often receive no encouragement whatever for so doing.

THE END.

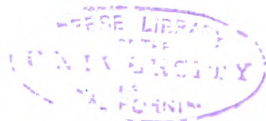

IF YOU WANT FIRST-CLASS

CONDUITS,
RUBBER COVERED WIRE,
TROLLEY WIRE OR SOFT COPPER WIRE,
MAGNET WIRE,
LAMP CORD,
ANNUNCIATOR WIRE,
OFFICE WIRE AND CABLES,
UNDERWRITERS' WIRE,
MOISTURE-PROOF HOUSE WIRE,
WEATHER-PROOF LINE AND FEEDER WIRE,
WEATHER-PROOF FEED R CABLES,
W. A. C FIRE AND MOISTURE-PROOF WIRE,
LEAD COVERED. { **ELECTRIC LIGHT CABLES, Underground,**
FIRE ALARM AND POLICE TELEGRAPH CABLES, Aerial
or Underground,
RAILWAY FEEDER CABLES, Underground,
TELEGRAPH CABLES, Aerial or Underground,
TELEPHONE CABLES, Aerial or Underground,
SUBMARINE CABLES, for any Service,
TERMINALS FOR ELECTRIC CABLES,
RAILWAY CABLE FEEDER HEADS AND JUNCTION BOXES,
CABLE HANGERS AND JOINTING MATERIALS AND TOOLS,

Send us a list of your needs and we will take pleasure in sending you samples and quotations. Inquiries cheerfully answered.

Standard Underground Cable Co.

GENERAL OFFICES.

Westinghouse Building, Pittsburgh, Pa.

OFFICERS:

Geo. Westinghouse, Jr., President.
 Joseph W. Marsh, Vice Pres & Genl. Mgr.
 Frank A. Rinehart, Secy & Treas.
 W. A. Conner, Gen'l Supt. Mfg Dept.
 C. M. Hagen, Auditor.

BRANCH OFFICES:

18 Times Building, NEW YORK.
542 The Rookery, CHICAGO.

**The Investigation
Is Conclusive** of others
to those who are
willing to be con-
vinced, when the
subject is that of the

**WEBSTER VACUUM FEED WATER
HEATER AND PURIFIER.**

We Always Say a good deal about it,
but our catalogue
contains both sides
of the story—that of
we, the makers, and
of those who use it.

Duplicate Orders (a vast num-
ber) clearly establish
the points involved.

**THE WEBSTER VACUUM SYSTEM
OF STEAM HEATING**

possesses the greatest
scope of advantages
known. Write to

**WARREN WEBSTER & COMPANY,
Camden, N. J.**

Exhaust Steam Specialists.

The Stirling Water Tube Boiler

SAFE, ECONOMICAL, EFFICIENT.

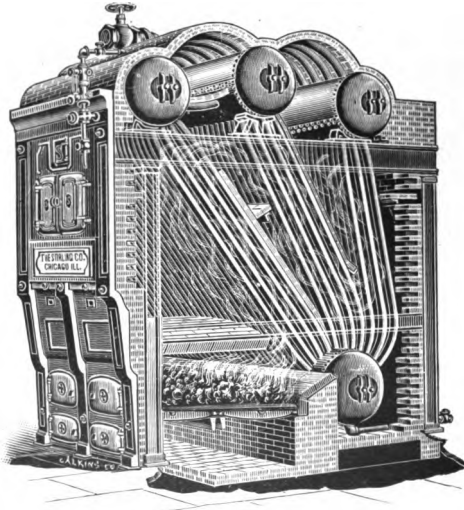

OVER 350,000 H. P. IN USE.

THE STIRLING CO.

Gen'l Office, Pullman Bldg.

Branches in All Cities.

Chicago, Ill.

LINK-BELT Engineering Co.
NICETOWN, PHILA.
49 DEY ST., NEW YORK.

... DESIGN AND ERECT ...

**Complete Power House Outfits of Coal
and Ashes Handling Machinery, in-
cluding Elevators, Conveyors,
Driving Machinery, Hop-
pers and Spouts.**

Recently Equipped in Philadelphia
and New York:

*Philadelphia Traction Co.'s 13th St. Power House,
Philadelphia Traction Co.'s 33d St. Power House,
Electric Traction Co.'s Beach St. Power House,
H., M. & F. P. Ry. Co.'s Callowhill St. Power House,
Broadway and 7th Ave. Ry. Co.'s Houston St. Power House.*

CHICAGO:

Link = Belt Machinery Company.

Westinghouse

ELECTRIC RAILWAY APPARATUS,

The Most Durable, Economical and Efficient on the Market.

DIRECT CONNECTED AND BELT DRIVEN
GENERATORS.

Instruments, Switchboards, Lightning Arresters, Car Equipments, Etc.

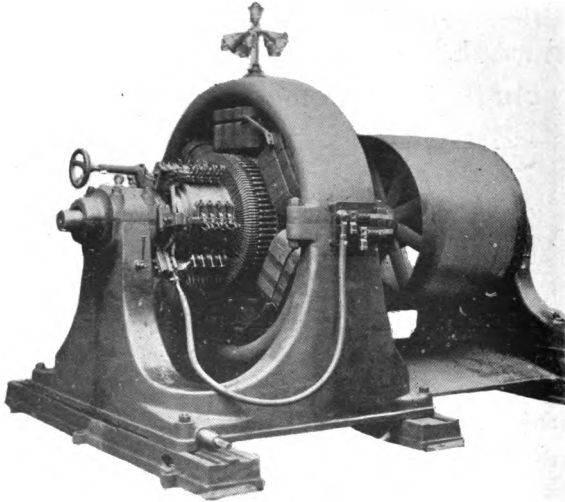

500 K. W. Belt Driven Railway Generator.

WESTINGHOUSE ELECTRIC AND MANUFACTURING CO.

PITTSBURG, Westinghouse, Building.
 BUFFALO, Erie County Bank Building.
 PHILADELPHIA, Girard Building.
 ST. LOUIS, American Central Building.
 NEW YORK, 120 Broadway.
 CHICAGO, New York Life Building.
 WASHINGTON, D. C., 1333 F St. N. W.
 TACOMA, WASH., 102 S. 10th St.
 CHARLOTTE, N. C., 36-38 College St.
 SYRACUSE, N. Y., Bastable Building.
 SAN FRANCISCO, Mills Building.
 BOSTON, Exchange Building.
 DALLAS, TEX., Trust Building.

Westinghouse Engines,

THREE TYPES:

Compound: 35 to 1000 H. P.

Standard: 5 to 250 H. P.

Jnnior: 5 to 75 H. P.

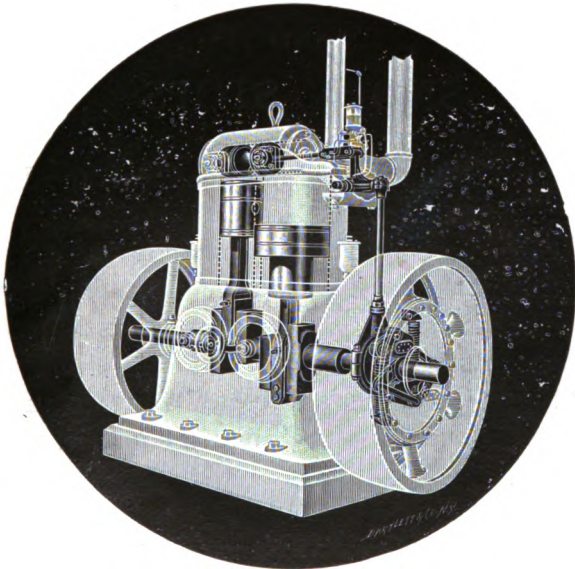

UNEQUALED ADAPTABILITY,
HIGH EFFICIENCY
AND MODERATE COST.

The Westinghouse Machine Company,

PITTSBURG, PA., U. S. A.

**DURABLE CARS
AND
SHORT STOPS**

are the two unrecognized needs of modern street-railroad service.

Cars have got to be honestly built, and they are not, except by two or three builders.

The door has got to be put at the step to shorten stops.

See "Car-buyer's Helper" for this and a great deal more. If you haven't got it, we'll send it.

BROWNELL CAR COMPANY.

Saint Louis, Missouri.

PHILADELPHIA CORLISS ENGINES,

TANGYE GIRDER BED.

FOR ALL KINDS OF ELECTRICAL WORK.

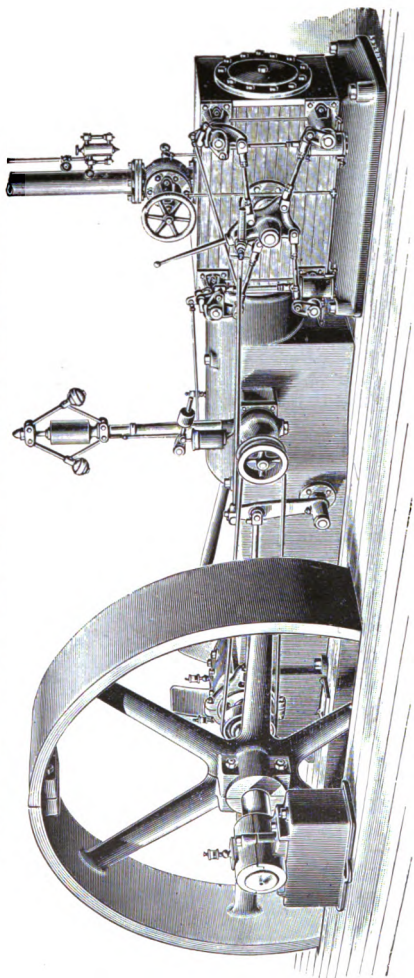

Catalogue Free on Application.

viii

COMPLETE STEAM PLANT EQUIPMENT.

PHILADELPHIA ENGINEERING WORKS, Ltd.

BOSTON.

PHILADELPHIA, PA., U. S. A.

NEW YORK

SCHAEFFER & BUDENBERG,

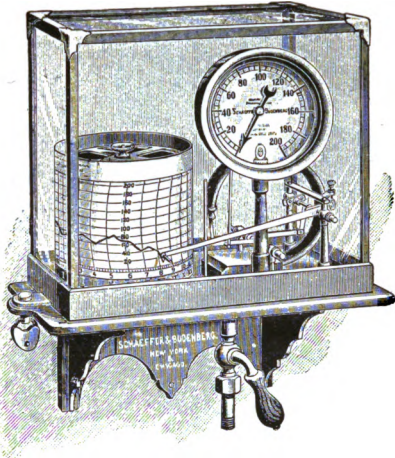

RECORDING GAUGE.

Prof. Carpenter's Steam
and Coal

CALORIMETERS,

Improved

Thompson Steam Engine Indicator,

Amsler Planimeters, Peer-
less Automatic Injectors,
Reducing Pulleys and En-
gine and Boiler Appliances
in general.

SALESROOMS:

No. 22 W. Lake Street,
CHICAGO.

No. 66 John Street,
NEW YORK.

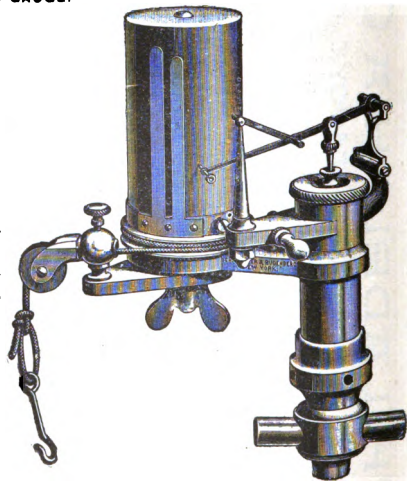

STEAM ENGINE INDICATOR.

Works and General Offices, - - BROOKLYN, N. Y.

Manufacturers of
Pressure Gauges

For All Purposes,

METROPOLITAN

Recording Gauges

for Low and High
Pressure,

TACHOMETERS,

Portable and Stationary,
also for direct attachment
to shafts of engines and
dynamos.

*Don't Make a Jack of the Motorman,
But equip your Cars and Car Barns with the
Barrett Lifting Jacks,*

*The Only
Ratchet Jack
That Lowers Load
Automatically.*

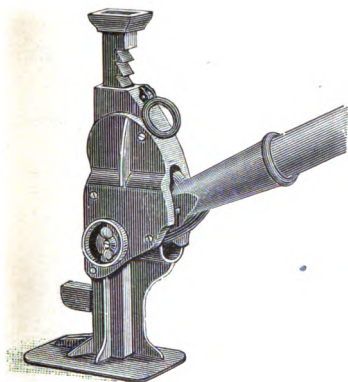

**AUTOMATIC LOWERING JACK NO. 2
FOR DERAILMENT.**

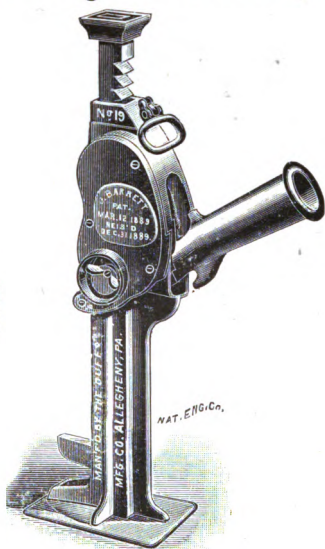

**AUTOMATIC LOWERING JACK NO. 19
FOR USE IN CAR BARN**

Our No. 2 Jack is being adopted by Cable and Electric Lines. It is easy to handle and takes but little space on cars. It is easily worked by both upward and downward movements of lever and has a capacity of 10 TONS. Weight, 60 pounds.

Our No. 19 is especially adapted for Car Barns. It is fast and has a very high lift. By use of side lug it can grapple low set loads with ease. Lifts or lowers on downward stroke of lever only. Height when rack is down, 28 inches. Rise of lifting rack, 17½ inches. Weight, only 90 pounds. Send for prices.

One of the "Barrett" Jacks should be in at least every other street car, so that in case of derailment, the Jack would be instantly at hand and the line would not be blocked and the passengers inconvenienced. Just one experience of this kind would more than pay the cost of Jack in the fares saved. One car off the track stops all others. The "Barrett" Jack reduces such risks to a minimum and in a year's traffic will save thousands of dollars.

The Duff Mfg. Co., Allegheny, Pa.

"STEEL IS STEEL."

GRAHAM'S "I" BEAM TRUCK.



ITS MERITS ARE

**Simplicity, Strength, Lightness, Smooth Riding,
Freedom from Oscillation,**

Easily started and stopped, therefore requiring less power and greatly reducing the wear and tear to track and equipment.

In Service in 100 Cities in United States and on
the Continent of Europe.

STEEL SNOW PLOWS,

No Motors, No Extra Crew.

STEEL FRAMED CARS

For All Classes of Service, Open and Closed.

The steel framing of our car is also the framing of the truck. We bolt the pedestals—which are in halves—directly to the "I" beam sills of the car; this enables us to sell you a car complete, with wheels ready for the motors, cheaper than a separate car body and separate truck. It is eight inches lower and two tons lighter than any car body to day being built. The car is entirely spring-suspended and equipped with **Graham's Equalized Brakes**, which enables the motorman to stop the car easier and quicker with full load than when empty. If you are interested, write for blue prints and photographs.

GRAHAM EQUIPMENT COMPANY,

Boston, Mass., U. S. A.

John A. Roebling's Sons Co.

TRENTON, N. J.

SPAN WIRE,

GUARD WIRE,

UNDERGROUND FEEDERS,

WEATHERPROOF FEEDERS,

MAGNET WIRE,

RUBBER WIRE.

All Wire Required for an Electric Railway.

Wm. Sellers & Co., Incorporated,

PHILADELPHIA, PA.

...Manufacturers of...

CRANES

Of Various Types and of Improved Designs.

Traveling Cranes For use in Electric Street
Railway Power Stations, a
specialty.

Machine Tools For Machine Shops, Railway
Repair Shops, Etc.

Injectors For All Classes of Boilers.

Shafting And all its accessories for transmitting
power.

Mechanical Stokers For Automatically Feed-
ing Fuel to Boilers with
Entire Absence of Smoke.

Turn-Tables, Testing Machines, Etc.

xiv

AETNA RAILWAY INSULATORS

STRENGTH.

PERMANENCE.

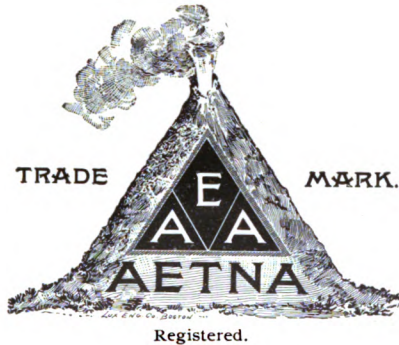

High Insulation.

Fully Guaranteed.

Anderson Line Material.

ALBERT and J. M. ANDERSON,
MAKERS,
289-293 A Street,

South Boston, Mass.

Established 1877.

NEW YORK CARBON WORKS,

Manufacturers of

... SELF-LUBRICATING ...

Dynamo  Motor Brushes

39 and 41 Cortlandt St.

... New York.

NOISELESS! DURABLE! CLEANLY!

Patent Raw Hide Pinions

For Electric Motors and High Speed Machinery Generally.

As is steel to iron, so is NEW PROCESS RAW HIDE to all other raw hide.

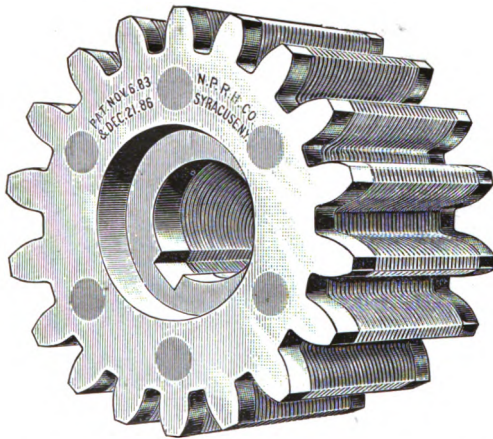

Adopted by over 50 Westinghouse roads.

—THE—

New Process Raw Hide Co.

Patentees and
Sole Manufacturers.

Syracuse, N. Y., U. S. A.

—THE—

Haller Tube Cleaner

—FOR—

Water Tube Boilers.

*Best,
Strongest
and Simplest.*

Do you have any trouble removing scale from your boiler?

If so, let us send you a Haller for a 30-day trial, and if it doesn't do the work to your satisfaction, return to us at our expense.

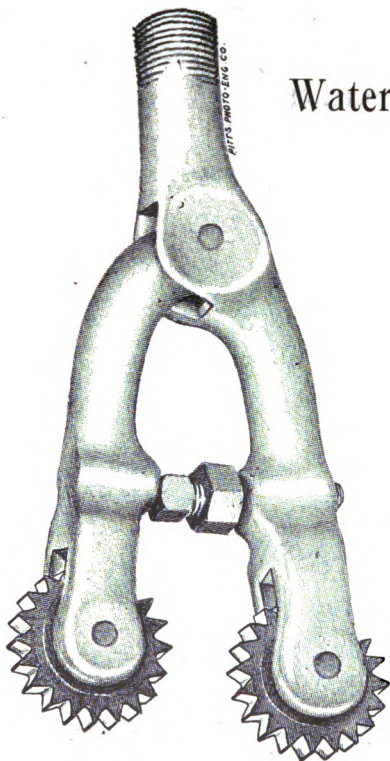

The McClain Manufacturing Co.

First National Bank Bldg.

PITTSBURG, PENNA.

Write for Descriptive Circular and Price List.

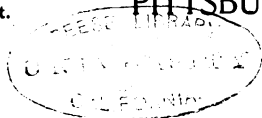

53635

RY

